

Guide for Source Inspection and Quality Surveillance of Fixed Equipment

Foreword

This guide has been developed to provide information for source inspectors for the purpose of providing a consistent method of Supplier/Vendor (S/V) quality surveillance for the oil, petrochemical and gas industries. It is intended as a resource for individuals studying to take the API Source Inspector Certification examination. Other references contained herein will also be necessary for individuals to become familiar with in order to pass the examination and to perform satisfactorily in the source inspection job. This study guide is also intended as a draft from which an API Recommended Practice for Source Inspection could eventually be formulated and published utilizing the ANSI standardization process.

Table of Contents

1	Scope/Purpose.....	1
2	Introduction.....	2
3	References.....	2
4	Definitions, Abbreviations and Acronyms.....	3
5	Training	10
5.1	General.....	10
6	Source Inspection Management Program.....	10
7	Project Specific Source Inspection Planning Activities	11
7.1	General.....	11
7.2	Equipment Risk Assessment	11
7.3	Development of a Source Inspection Project Plan.....	13
7.4	Development of Inspection and Test Plans	13
7.5	Selection of an Inspector.....	13
7.6	Coordination of Inspection Events	13
7.7	Report Review.....	13
8	Source Inspection Performance.....	14
8.1	Inspector Conduct and Safety.....	14
8.2	Review of Project Documents	14
8.2.1	General.....	14
8.2.2	Contractual Agreements	14
8.2.3	Engineering Design Documents.....	14
8.2.4	Company and Client Standards	15
8.2.5	Industry Codes and Standards.....	15
8.2.5.1	General.....	15
8.2.5.2	API Codes and Standards.....	15
8.2.5.3	ASME Codes and Standards	16
8.2.5.4	ASNT Standards	19
8.2.5.5	AWS Standards and References	19
8.2.5.6	SSPC Standards	20
8.2.6	Welding Procedures and Qualifications	20
8.2.7	NDE Procedures	20
8.2.8	Project Schedules	21
8.3	Performing the Source Inspection.....	21

8.4	Source Inspection Work Process Scheduled Planning Events.....	21
8.4.1	General.....	21
8.4.2	Pre-purchase Meeting (Prior to Contract Placement)	21
8.4.3	Pre-inspection Meeting (Prior to Start of Fabrication).....	21
8.5	Report Writing	22
8.6	Nonconformance/Deviations	23
8.7	Source Inspection Project Continuous Improvement.....	23
8.8	Source Inspector Continuous Improvement.....	24
9	Examination Methods, Tools and Equipment	24
9.1	General.....	24
9.2	Review and Confirmation of Materials of Construction	24
9.3	Dimensional Inspections	25
9.4	Visual Inspections	25
9.5	Nondestructive Examination (NDE) Techniques.....	26
9.5.1	General.....	26
9.5.2	Penetrant Testing (PT)	26
9.5.3	Magnetic Testing (MT)	26
9.5.4	Radiographic Testing (RT)	26
9.5.5	Ultrasonic Testing (UT)	26
9.5.6	Hardness Testing (HT).....	26
9.5.7	Positive Material Identification (PMI).....	26
9.6	Destructive Testing	26
9.7	Pressure/Leak Testing	27
9.7.1	General.....	27
9.7.2	Pressure Testing	27
9.8	Performance/Functional Testing	28
9.9	Surface Preparation/Coatings Inspections.....	28
10	Final Acceptance	28
11	Manufacturing and Fabrication (M&F) Processes.....	29
11.1	General.....	29
11.2	Welding Processes and Welding Defects	30
11.3	Casting	30
11.4	Forging	31
11.5	Machining.....	31
11.6	Assembly.....	32

11.7	Metallurgy Issues Associated with Manufacturing and Fabrication Processes	32
11.7.1	The Structure and Metals	32
11.7.2	Physical Properties of Metals	32
11.7.3	Mechanical Properties of Metals	32
11.7.4	Hardness and Hardenability of Metals	32
11.7.5	Weldability of Metals	33
11.7.6	Preheating and Postweld Heat Treatment	33
11.7.6.1	Preheating	33
11.7.6.2	Postweld Heat Treatment (PWHT).....	33
11.7.6.3	Other Heat Treatments.....	34
12	Pressure Vessels	34
12.1	General.....	34
12.2	Vessel Methods of Construction	34
12.3	Vessel Materials of Construction.....	34
12.4	Vessel Internal Components	36
12.5	Vessel Design and Construction Standards	36
12.6	Dimensional Check of Pressure Vessels	37
12.7	Heat Exchangers.....	38
13	Piping	39
13.1	General.....	39
13.2	Valves.....	39
13.3	Flanges.....	40
13.4	Fittings.....	42
14	Structural Components.....	42
	Annex A.....	44
	Annex B	45
	Annex C	51

Guide for Source Inspection and Quality Surveillance of Fixed Equipment

1 Scope/Purpose

This study guide covers the process of providing quality surveillance of materials, equipment and fabrications being supplied for use in the oil, petrochemical and gas Industry, including upstream, midstream and downstream segments. This guide may be used as the basis for providing a systematic approach to risk-based source inspection in order to provide confidence that materials and equipment being purchased meet the minimum requirements as specified in the project documents and contractual agreements. The activities outlined in this study guide **do not** intend to replace the manufacturer's/fabricator's own quality system, but rather are meant to guide source inspectors acting on behalf of purchasers to determine whether manufacturers/fabricators own quality systems have functioned appropriately, such that the purchased equipment and materials will meet contractual agreements.

This study guide focuses primarily on pressure containing and structural equipment (fixed equipment) including: vessels, columns/towers, heat exchangers, piping, valves, pressure relief devices, tubulars, and associated structural fabrications. This document assumes that suppliers/vendors (S/V) have been pre-qualified by a systematic quality review process of their facilities and quality process to determine if the facility has the ability to meet the requirements of the contractual agreements. That process generally leads to a list of pre-approved S/V's deemed acceptable to the supply chain management of the purchaser and capable of meeting the requirements of the contract prior to it being placed. S/V's on such a list will normally have an acceptable quality process already in place that meets the requirements of the contract. The purpose of source inspection in such a case is simply to verify that the S/V quality process is working as it should and to verify that certain vital steps in the inspection and test plan (ITP) have been satisfactorily accomplished prior to fabrication completion and/or shipping.

The primary purpose of this study guide is to assist candidates intending to take the API source inspection examination to become certified source inspectors. The study guide outlines the fundamentals of source inspection and may be useful to all personnel conducting such activities to perform their jobs in a competent and ethical manner. For more information on how to apply for Source Inspection Certification, please visit API website at <http://www.api.org/certification-programs/icp/programs> and follow the work process shown in chart below.

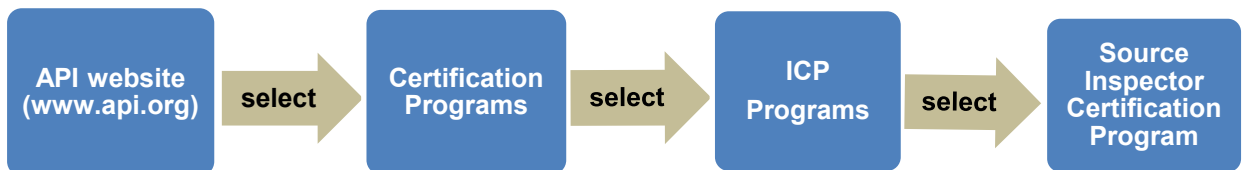

The Source Inspector Examination contains 100 multiple-choice questions targeting core knowledge necessary to perform source inspection of fixed equipment. The focus of the exam is on source inspection issues and activities rather than design or engineering knowledge contained in the reference standards. The exam is closed book and administered via computer based testing (CBT). The bulk of the questions address mechanical inspection/surveillance which are typically known by persons who have experience working as source inspectors or persons intending to work as source inspectors who have studied the material in this study guide and the associated reference materials.

2 Introduction

Like most business processes, the Source Inspection work process follows the Plan–Do–Check–Act circular process first popularized in the 1950’s by Edward Deming. The “Planning” part of source inspection is covered in Sections 6 and 7 of this study guide and involves the source inspection management systems, source inspection project plan and the inspection and test plan (ITP). The “Doing” part is covered in Sections 8 and 9 and involves implementing the ITP, participating in scheduled source inspection work process events, filing nonconformance reports and source inspection report writing. The “Checking” part, covered in Section 8.7, involves looking back at all the source inspection activities that occurred in the Planning and Doing segments to see what went well and what should be improved based on the results of that look-back. And finally the “Act” part (sometimes called the “Adjust” part) covered in Section 8.8 involves implementing all the needed improvements in the “Planning and Doing” process before they are implemented on the next source inspection project.

3 References

The most recent editions of these codes, standards or other recommended practices are referenced in this study guide and are the documents from which the SI exam has been developed.

API (American Petroleum Institute)

RP 572	<i>Inspection Practices for Pressure Vessels</i>
RP 577	<i>Welding Inspection and Metallurgy</i>
RP 578	<i>Material Verification Program for New and Existing Alloy Piping Systems</i>
Std 598	<i>Valve Inspection and Testing</i>

ASME (ASME International; formerly known as American Society of Mechanical Engineers)

Boiler and Pressure Vessel Code (BPVC)

- Section II—*Materials*, Parts A, B, C, and D
- Section V—*Nondestructive Examination*
- Section VIII—*Rules for Construction of Pressure Vessels*, Divisions 1 and 2
- Section IX—*Welding and Brazing Qualifications*

B31.3 *Process Piping*

B16.5 *Pipe Flanges and Flanged Fittings*

ASNT (American Society of Nondestructive Testing)

SNT-TC-1A *Personnel Qualification and Certification in Nondestructive Testing*

AWS (American Welding Society)

D1.1 *Structural Welding Code*

Welding Inspector Handbook

Society for Protective Coatings (SSPC)

SSPC-PA 2 *Procedure for Determining Conformance to Dry Coating Thickness Requirements*

SSPC Surface Preparation Guide

4 Definitions, Abbreviations and Acronyms

For the purposes of this study guide, the following definitions, abbreviations and acronyms apply. Additional definitions which the source inspector needs to know and understand are included in the following documents:

- API RP 577, Section 3
- API RP 578, Section 3
- ASME B31.3, 300.2
- ASME *BPVC* Section VIII, Division 1, Appendix 3
- ASME *BPVC* Section V, Subsection A, Article 1, Appendix 1
- ASME *BPVC* Section V, Subsection B, Article 30, SE-1316
- AWS D1.1, Annex K

AARH	Arithmetic Average Roughness Height (a measure of surface roughness)
Annealing Heat Treatment	Heating an object to and then holding it at a specified temperature and then cooling at a suitable rate for such purposes as: reducing hardness, improving machinability, facilitating cold working, producing a desired microstructure, or obtaining desired mechanical properties.
ANSI	American National Standards Institute
API	American Petroleum Institute
ASME	ASME International (formerly known as the American Society of Mechanical Engineers)
ASNT	American Society of Nondestructive Testing
ASTM	ASTM International (formerly known as the American Society for Testing and Materials)
BOK	Body of Knowledge (in this case the BOK for the Source Inspector examination)
BPVC	<i>Boiler and Pressure Vessel Code</i> (published by ASME)
C	The chemical symbol for carbon which may appear on a MTR.
Certification	Documented and signed testimony of qualification. Certification generally refers to the confirmation of certain, specified characteristics of a product or confirmation of a person meeting requirements for a specific qualification.

Calibration	A comparison between measurements—one of known magnitude or correctness (the standard) compared to the measuring device under test in order to establish the accuracy of a measuring device.
Cladding	A metal integrally bonded onto another metal (e.g. plate), under high pressure and temperature whose properties are better suited to resist damage from the process fluids than the underlying base metal.
Cold Working	Plastic deformation (forming, rolling, forging, etc.) of metals below the recrystallization temperature of the metal.
Cr	The chemical symbol for chromium which may appear on an MTR.
Critical Equipment	Equipment that has been risk assessed and determined that if it were to fail in service, it would have an unacceptable impact on process safety, environment, or business needs and therefore deserves a higher level of source inspection attention to make sure the equipment being delivered is exactly as specified.
Cu	The chemical symbol for copper which may appear on a MTR.
Destructive Testing	Various tests that are performed on metals for the purposes of determining mechanical properties and which involve testing (usually breaking) of sample coupons. Examples of such tests include tensile testing, bend testing and Charpy impact testing. A destructive testing work process involves extracting samples/coupons from components and testing for characteristics that cannot otherwise be determined by nondestructive testing. The work process involves breaking and/or testing coupons/samples to failure, thus usually rendering the component from which the samples were extracted unfit for continued service.
Deviation	A departure from requirements in the contractual agreements or its referenced PO, engineering design, specified codes, standards or procedures.
DFT	Dry Film Thickness (of paint and coatings) which is measured by a DFT gauge.
Elevation	The height of any point on a vessel as shown on a vessel drawing e.g. nozzle, manway, or longitudinal weld as measured from a base plate or other reference line such as the bottom head tangent line.
Employer	The corporate, public or private entity which employs personnel for wages, salaries, fees or other considerations e.g. the employer of the source inspector.
Engineered Equipment	Equipment that is custom designed and engineered by the client and/or EPC to perform a project-specific function. Engineered equipment will typically require more source inspection than non-engineered equipment.
EPC	Engineering/Design/Construction contract company.
Examiner	A person who performs specified nondestructive examination (NDE) on components and evaluates the results to the applicable acceptance criteria to assess the quality of the component. Typically NDE examiners

(sometimes called NDE technicians) are qualified to ASNT NDE personnel qualification practices e.g. SNT-TC-IA or CP-189.

Fe	The chemical symbol for iron which may appear on an MTR.
Ferrous Materials	Alloys that are iron based, including stainless steels.
HAZ	Heat Affected Zone, which is the base metal area next to the weld that has had its metal structure affected by the heat of welding.
Hot Working	Plastic deformation (forming, rolling, forging, etc.) of metals at a temperature above the metal recrystallization temperature.
ICP	Individual Certification Program (of the API) under which this source inspector certification program is administered.
Inspection	The evaluation of a component or equipment for compliance with a specific product specification, code, drawing and/or standard specified in the contractual requirements, which may include the measuring, testing or gauging of one or more characteristics specified for the product to determine conformity.
Inspection Agency	An entity employed to provide competent, qualified and certified source inspection personnel for the purpose of performing source inspection. For example, an inspection agency can be an EPC company, an owner-user, or an inspection service company.
Inspection Coordinator	Individual who is responsible for the development of the source inspection strategy, coordination of the source inspection visits, and implementation of the source inspection activities on a project.
Inspection Waiver	Permission to proceed with production/shipment without having a purchaser source inspection representative present for a specific activity.
ITP	Inspection and Test Plan—A detailed plan (checklist) for the source inspection activities which will guide the source inspector in his/her quality assurance activities at the S/V site with reference to applicable technical information, acceptance criteria and reporting information. The supplier/vendor should also have their own ITP to guide their fabrication personnel and quality assurance personnel in the necessary quality steps and procedures.
Lamination	A type of discontinuity with separation or weakness generally aligned parallel to the worked surface of a plate material. In a forging it can rise to the surface or occur internally; it is generally associated with forging at too low of a temperature or in plate material may be caused by the tramp elements that have congregated in the center of the plate during rolling.
Levelness	The position of a surface of a component or structure that is horizontal (within tolerances) with the base plate and at 90 degrees to the vertical plumb line. Nozzle and attachment levelness tolerances are not addressed in ASME <i>BPVC</i> Section VIII, Division 1; however, in the pressure vessel handbook, a ½° tolerance is permissible. For levelness checking of a nozzle on a vessel, a level gauge is used. If the bubble is in the middle of the designated lines, the nozzle is level. A level gauge

would be used for verification and measurement that the angle of a hillside (tangential) nozzle is properly installed relative to the vessel centerline.

MAWP	Maximum Allowable Working Pressure—The maximum gauge pressure at the top of a pressure vessel allowed by code calculations for a designated temperature.
M/F	Manufacturer/Fabricator—An organization that has been contracted for and has the primary responsibility for producing the product/equipment items e.g. vessels, exchangers, piping, valves, etc. in conformance with contractual documents.
M&F	Manufacturing and Fabrication—Refers to the various material working processes that are commonly used to produce a product such as welding, joining, heat treatment, casting, forming, forging, bending, machining, assembly, etc.
Mg	The chemical symbol for magnesium which may appear on an MTR.
Mn	The chemical symbol for manganese which may appear on an MTR.
Mo	The chemical symbol for molybdenum which may appear on an MTR.
MSS	Manufacturers Standardization Society
MT	Magnetic Particle Testing (Examination)
MTR	Material Test Report or Mill Test Report—A document that certifies that a metal/material product is in conformance with the requirements (e.g. chemical and mechanical properties) of a specified industry standard—such as ASTM, ASME, etc.
NB	National Board
Nb	The chemical symbol for niobium which may appear on an MTR.
NCR	Nonconformance Report—A report filled out by the SI detailing an issue that has been discovered to be not in accordance with project contractual agreements such as the PO, engineering design, specified codes, standards or procedures.
NDE Map	A drawing which identifies specific locations where NDE has been conducted on a product/component.
NDE/NDT	Nondestructive Examination (the preferred terminology)/Nondestructive Testing (the outdated terminology). A quality process that involves the examination, testing and evaluation of materials, components or assemblies without affecting its functionality e.g. VT, PT, MT, UT, RT.
NDT	Nondestructive Testing—Means the same as NDE, which is now the preferred terminology.
Ni	The chemical symbol for nickel which may appear on an MTR.
Nonconformance	A departure/deviation from project contractual agreements such as the PO, engineering design, specified codes, standards or procedures.

Non-engineered Equipment	Equipment that is designed and fabricated by S/V's, which includes off-the-shelf items such as valves, fittings, as well as some skid units, instruments, pumps and electrical gear. Such equipment is usually purchased by catalog model numbers, etc. Non-engineered equipment will typically require less source inspection than engineered equipment.
Non-ferrous Materials	Alloys that are not iron based e.g. nickel and copper based alloys.
Normalizing Heat Treatment	A heat treating process in which a ferrous material or alloy is heated to a specified temperature above the transformation range of the metal and subsequently cooled in still air at room temperature. Typically normalizing heat treatments will refine the grain size and improve the impact properties of steels.
NPS	Nominal Pipe Size—A standard for designating pipe sizes (inches) and associated wall thickness (schedule) e.g. the nominal pipe size for a four inch pipe is normally shown as NPS 4.
Orientation	The orientation of a nozzle or attachment is the number of degrees off from a vertical centerline (a circumferential degree line) of the attachment or nozzle on the plan view of a vessel. For example, orientation of a nozzle or attachment can be checked with a protractor or smart level.
Out-of-Roundness	A deviation from perfect roundness e.g. ovality in a vessel circumference. ASME <i>BPVC</i> Section VIII, Division 1, UG 80 deals with out of roundness of a vessel shell. The maximum permitted ovality tolerance ($D_{max} - D_{min}$) shall not exceed 1% of the nominal diameter of the vessel.
P	The chemical symbol for phosphorus which may appear on an MTR.
PQR	Procedure Qualification Record per ASME <i>BPVC</i> Section IX, QW 200.2
Pressure Vessel	A container designed to withstand a specified amount of internal or external pressure generally above 15 psig. This definition includes heat exchangers, air-coolers, columns, towers, unfired steam generators (boilers) and other vapor generating vessels.
Procedure	A document detailing how a work process is to be performed e.g. a welding procedure.
Projection	A nozzle or attachment projection is the length from the nozzle or the attachment face to the vessel shell centerline.
Protractor	An instrument for measuring angles, typically in the form of a flat semicircle marked with degrees along the curved edge.
PRV/PRD/PSV	Pressure Relief Valve/Pressure Relief Device/Pressure Safety Valve
PT	Penetrant Testing (Examination)
QA	Quality Assurance—A proactive quality process that aims to prevent defects and refers to a program of planned, systematic and preventative activities implemented in a quality system that is intended to provide a degree of confidence that a product will consistently meet specifications.

It includes the systematic measurement, comparison with a standard, monitoring of processes and an associated feedback loop that is intended to avoid deviations from specification.

QC	Quality Control—The specific steps in a QA process that aim to find potential defects in a product before it is released for delivery e.g. VT, PT, RT, UT, dimensional verification, etc. The QA process will specify the particular QC steps necessary during manufacture/fabrication of a product.
Qualification	Demonstrated skill, demonstrated knowledge, documented training, and documented experience required for personnel to perform the duties of a specific job e.g. a certified source inspector.
Quality Surveillance	The process of monitoring or observing the inspection activities associated with materials, equipment and/or components for adherence to the specific procedure, product specification, code or standard specified in the contractual requirements. For the purposes of this guide, quality surveillance and source inspection mean the same thing (see definition for source inspection).
Quenching	Rapid cooling of a heated metal for the purpose of affecting mechanical and/or physical properties.
RMS	Root Mean Square—A measure of surface finish on flanges.
RT	Radiographic Testing (Examination)
Rust Bloom	The term used to describe surface discoloration that occurs on the surface of steel that has been previously blasted e.g. near-white or white metal in preparation for coating. When rust bloom is found, the surface should generally be re-cleaned before coating using the same blast cleaning process.
S	The chemical symbol for sulfur which may appear on an MTR.
SDO	Standards Development Organization e.g. API, ASME, ASTM, NACE, MSS, TEMA, etc.
SI	Source Inspector or Source Inspection
SME	Subject Matter Expert
Solution Anneal Heat Treatment	Heating an alloy to a specified temperature, holding at the temperature long enough for one or more elements to reenter into solid solution and then cooling rapidly enough to hold those elements in solid solution.
SOR	Supplier Observation Reports—Documents filled out by the SI indicating concerns or other factual descriptions of what was noticed during the course of product surveillance, but not necessarily issues that may be considered defects or requiring NCR's.
Source Inspection	The process of providing quality surveillance of materials, fabrications and equipment being supplied by supplier/vendor (S/V) or manufacturer/fabricator (M/F) for use in the oil, petrochemical and gas industry, including upstream, midstream and downstream segments.

Source inspection largely consists of verifying that the S/V's own quality assurance process is functioning as it should to produce quality products that meet the contractual agreements.

Source Inspector	Individual responsible for performing the actual source inspection activities at the S/V facilities in accordance with the applicable inspection and test plan (ITP).
Specification	A document that contains the requirements for the M&F of specific types of equipment and components.
SSPC	Society for Protective Coatings
S/V	Supplier/Vendor—The entity which is responsible for the actual manufacturing and fabrication (M&F) of the material, equipment or components and which is responsible for meeting the contractual requirements.
TEMA	Tubular Exchanger Manufacturers Association
Tempering	Reheating a hardened metal to a temperature below the transformation range to improve toughness.
Ti	The chemical symbol for titanium which may appear on an MTR.
Tolerance	Engineering tolerances refer to the limit (or limits) of specified dimensions, physical properties or other measured values of a component.
Training	An organized program developed to impart the skills and knowledge necessary for qualification as a source inspector.
UT	Ultrasonic Testing (Examination), generally for finding component flaws or measuring thicknesses.
VT	Visual Testing (Examination)
Weld Mismatch	The deviation from perfect alignment between two pieces of metal welded together. ASME <i>BPVC</i> Section VIII, Division 1 specified tolerances for weld mismatch are in UW-33. It is important for the SI to measure weld mismatch with a welding gauge and to know that the limit for weld mismatch is stringent for a category A weld (Longitudinal joint and circumferential shell to hemispherical head). The concept behind this is that the longitudinal joint bears double the amount of stress, and inspectors should precisely check these joints.
Weld Reinforcement	The height of the weld cap. The longitudinal joint weld reinforcement limit is more stringent than that for circumferential joints. This is because longitudinal joint bears double stress, and it is required that the stress concentration be minimized. Maximum weld reinforcement is specified in ASME <i>BPVC</i> Section VIII, Division 1.
WPQ	Welding Performance Qualification Record per ASME <i>BPVC</i> Section IX, QW 301.4
WPS	Welding Procedure Specification per ASME <i>BPVC</i> Section IX, QW 200.1

Websites Useful to the Source Inspector

API	American Petroleum Institute	http://www.api.org
ASM	American Society for Metals	http://www.asminternational.org/portal/site/www/
ASME International	Formerly known as American Society for Mechanical Engineers	http://www.asme.org
ASNT	American Society for Nondestructive Testing	http://www.asnt.org
ASTM International	Formerly known as American Society for Testing and Materials	http://www.astm.org
AWS	American Welding Society	http://www.aws.org
ISA	Instrument Society of America	http://www.isa.org
ISO	International Organization for Standardization	http://www.iso.org/iso/home.html
MSS	Manufacturers Standardization Society	http://mss-hq.org/Store/index.cfm
NDT Resource Center	Nondestructive Testing Resource Center	http://www.ndt-ed.org
NEC	<i>National Electric Code</i>	http://www.nfpa.org
SSPC	The Society for Protective Coatings	http://www.sspc.org/
Worldsteel	Worldsteel Association	http://www.steeluniversity.org

5 Training

5.1 General

Training and Certification for vendor/source inspection is unique to each organization. This study guide and supporting examination is designed to provide a minimum competency for a Mechanical Fixed Equipment Inspector.

6 Source Inspection Management Program

6.1 Employers or inspection agencies tasked with the responsibility of performing source inspection coordination and/or source inspection activities should develop a management program in order to provide the individuals performing the specific source inspection functions the necessary information to accomplish their duties. These source inspection management programs are generic in nature in that they provide requirements and guidance of source inspection activities on all types of projects that will require source inspection. See Section 7 for the types of source inspection plans that are needed for each specific project.

6.2 Source inspection management programs should cover most of the generic activities identified in this study guide but also include company specific information like:

- What activities need to be accomplished
- Who is responsible to accomplish each of the activities i.e. personnel titles
- The training and competencies required for source inspectors

- When or how frequently each of the activities will be accomplished
- How each of the activities will be accomplished i.e. specific work procedures
- Application of acceptance criteria and industry standards

6.3 These management programs may reference many other company specific source inspection procedures, practices and policies with more details that will be needed for specific types of source inspection activities, for example:

- How to prepare an overall Source Inspection Plan for an entire project and an Inspection and Test Plan (ITP) for each equipment item
- How to conduct an equipment risk assessment in order to determine the level of source inspection activities that will be required
- Guidance on the criteria to use for selecting source inspectors to match their skills and training with different types of equipment with different risk levels
- Guidance on scheduling and conducting significant source inspection events like the pre-inspection (fabrication kick-off) meeting, the S/V quality coordination meeting, final acceptance testing, etc.
- Guidance on SI safety and professional conduct at S/V shops
- How to review welding procedures and welder qualification documents
- How to review inspection/examination records of the S/V
- What inspections should be repeated by the source inspector to verify the results of S/V examinations and tests
- How to handle change requests
- How to handle deviations and nonconformances
- How to write source inspection reports with specific forms to be filled out
- What specific steps to take before approving product acceptance, etc.
- Interfacing with the jurisdictional authorized inspector

7 Project Specific Source Inspection Planning Activities

7.1 General

From the Source Inspection Management Program documents, a Project Specific Inspection Plan should be developed by the inspection coordinator addressing the following activities.

7.2 Equipment Risk Assessment

7.2.1 Effective source inspection for each project begins with a risk-based assessment of the materials and/or equipment to be procured for the project. These risk based assessments are performed to identify the level of effort for source inspection activities during the M&F phase of a project at the S/V facility. Equipment identified as critical equipment will receive more intensive source inspection; while equipment identified as less critical will receive less intensive source inspection and thereby rely more on the S/V quality program.

7.2.2 Typically these risk based assessments occur early in the design stages of a project and identify the equipment risks into the following types of categories.

- Safety or environmental issues that could occur because of equipment failure to meet specification or failure while in service
- Equipment complexity; the more complex the equipment, the higher level of source inspection may be required
- Knowledge of S/V history and capabilities to deliver equipment meeting specifications on time i.e. newer S/V with relatively unknown history or capabilities may need closer scrutiny
- Potential schedule impact from delivery delays or project construction impact from issues discovered after delivery i.e. long delivery items may require higher level of source inspection
- Equipment design maturity level i.e. prototype, unusual or one-of-a-kind type equipment may require higher level of source inspection
- Lessons learned from previous projects i.e. has the S/V had problems in the past meeting specifications on time?
- Potential economic impact on the project of S/V failure to deliver equipment meeting specifications on time

7.2.3 The risk based assessment team typically consists of individuals from various company groups including: quality, engineering, procurement, construction, project management and source inspection. Input from those who will own and operate the equipment i.e. the client is also beneficial. This collaboration provides input from all parties that may be affected if material or equipment is delivered and installed with unacceptable levels of quality.

7.2.4 The risk assessment process takes into account the probability of failure (POF) of equipment to perform as specified, as well as the potential consequences of failure (COF) to perform in service e.g. safety, environmental and business impact. The ultimate risk associated for each equipment item is then a combination of the POF and COF assessments.

7.2.5 The risk assessment provides the information necessary for the inspection coordinator to specify a level of effort for source inspection of each S/V facilities commensurate with the agreed upon risk level. Typical levels of source inspection effort at the S/V facility commensurate with risk levels may include:

- No Source Inspection (lowest risk for equipment failure to meet specifications; rely solely on S/V quality).
- Final Source Inspection (final acceptance) only just prior to shipment (lower to medium risk material or equipment; rely primarily on S/V quality with minimum source inspection).
- Intermediate Source Inspection level (medium to medium high risk equipment; mixture of reliance on S/V quality with some source inspection activities at the more critical hold points). The number of shop visits may go up or down based on the performance level of the S/V.
- Advanced Source Inspection level (higher risk equipment; significant amount of source inspection e.g. weekly to provide higher level of quality assurance). The number of shop visits may go up or down based on the performance level of the S/V.

- Resident Source Inspection level [highest risk equipment; full time shop inspector(s) assigned, possibly even on all shifts].

7.3 Development of a Source Inspection Project Plan

7.3.1 A source inspection plan should be developed for projects that have materials or equipment which will be inspected for compliance to the contractual agreements, project specifications, drawings, codes and standards.

7.3.2 The project plan should consist of the project details, list of equipment to be inspected and the project specific details on how the inspection activities will be performed to meet the expected level of quality performance from the S/V and/or the equipment.

7.3.3 The plan should also be based upon the level of risk determined from the risk based assessment performed in the design stage of the project and the appropriate level of effort needed for the surveillance of the S/V that is commensurate with the risk level.

7.4 Development of Inspection and Test Plans

7.4.1 A detailed inspection and test plan (ITP) for each type of equipment to be inspected should be provided. This ITP should be specific to the type of equipment to be inspected, the associated risk level for each piece of equipment and should identify all the inspection activities necessary to be performed by the assigned source inspector. It should also include the appropriate acceptance criteria or reference theretofore.

7.4.2 The source inspector should follow the ITP and ensure that the fabrication and S/V quality activities performed meet the requirements specified in the contractual agreement, referenced project specifications, drawings, applicable codes and/or standards.

7.5 Selection of an Inspector

7.5.1 The source inspection coordinator should review the details of the project plan, location of the S/V and duration of the work and select the appropriate source inspector(s) for the assignment.

7.5.2 The source inspector(s) selected should have the necessary experience, training and qualifications to perform the inspection or surveillance activities referenced in the ITP.

7.6 Coordination of Inspection Events

Dates for source inspection scheduled work process events such as the pre-inspection meeting (fabrication kickoff), key inspection events (factory acceptance, performance testing and final inspection) and anticipated shipping date should be identified in advance to allow coordination with other project members involved in the activity.

7.7 Report Review

Source inspection reports are important deliverables from the SI to the project team or client. The amount and type should be specified in the ITP. Each inspection report should be reviewed for content, completeness and technical clarity prior to distribution.

8 Source Inspection Performance

8.1 Inspector Conduct and Safety

8.1.1 Individuals tasked with the responsibility of performing source inspection activities should conduct themselves professionally while visiting an S/V facility as a representative of their employer and/or purchaser. If any conflict should arise during the inspection activity, the source inspector should notify their supervisor for resolution as soon as possible. It is important that the SI not be confrontational or argumentative regardless of the importance of the issue at hand; but rather simply indicate in objective terms how the SI intends to proceed to resolve the issue.

8.1.2 Safety of the individual performing the source inspection activity is one of the most important aspects of their work. A safety program should be established which identifies specific safety hazards associated with the job. Source Inspectors should be adequately trained and knowledgeable in these safety programs in order to minimize the possibility of injury. The safety program should include:

- Potential travel safety issues specific to the job
- Potential shop safety issues and hazard recognition
- How to handle the observation of unsafe acts in the shop

8.1.3 The SI should observe the safety procedures and policies of the S/V while on their premises or if more stringent, their own company safety requirements.

8.2 Review of Project Documents

8.2.1 General

8.2.1.1 Typical project documents include but are not limited to contractual agreements (purchase orders and/or subcontracts), source ITP, project specifications, engineering or fabrication drawings, applicable codes, references or standards.

8.2.1.2 The source inspectors should familiarize themselves with all project documents and ensure that they have access to the specific edition/version of those documents specified in the contractual agreement at all times during their inspection visits. Prior to commencing the quality surveillance specified in the ITP, the source inspector should confirm that the S/V has the most current documents, drawings, etc. specified in the engineering design. Later editions of industry codes and standards do not apply if the engineering design has specified an earlier edition of a specific standard. Additionally, the source inspector should confirm that that all project documents have been reviewed/approved by the purchaser.

8.2.2 Contractual Agreements

The contractual agreements including the purchase order, all specified engineering design documents, specified company standards, and specified industry standards form the basis for the requirements for source inspection of the purchased products.

8.2.3 Engineering Design Documents

For engineered equipment, the SI needs to be familiar with the engineering design documents and drawings that are vital to quality of the purchased products.

8.2.4 Company and Client Standards

The SI needs to be familiar with all company and client standards that are specified in the contractual agreements. These standards typically augment or supplement industry standards for issues not sufficiently well covered in industry standards. All mandatory requirements i.e. “shall/must” statements, included in the company specifications must be met or become an issue for an NCR and handled in accordance with standard purchaser management NCR systems requirements. Other issues contained in the specified standards such as those suggested or recommended i.e. “should” statements which are expectations of the S/V, but not necessarily requirements may become an issue to be reported in Supplier Observation Reports (SOR’s) and handled in accordance with standard purchaser management systems. Company and client standards may cover engineered and non-engineered equipment.

8.2.5 Industry Codes and Standards

8.2.5.1 General

The SI needs to be familiar with all industry codes and standards that are specified in the contractual agreements to the extent that requirements and expectations in those codes and standards are part of the contractual agreements and therefore part of the source inspector duties. Those industry codes and standards are typically published by recognized industry standards development organizations (SDO’s), such as those in the following subsections.

8.2.5.2 API Codes and Standards

There are a wide variety of API Codes and Standards that may be included in the contractual agreements to specify and control the quality of products for the energy industry. A few of those that the SI should be familiar with and apply when specified are shown in the following subsections; but this list is not all inclusive. Others that are specified in the contractual agreements may be equally important to the quality of the delivered product. The information contained in the following industry standards is generic to a wide variety of products and therefore should be general knowledge to the experienced SI.

- **API RP 572, *Inspection Practices for Pressure Vessels*.** This RP includes a description of the various types of pressure vessels and the materials and standards for their fabrication. The source inspector should be familiar with Sections 3 and 4 of this RP.
- **API RP 577, *Welding Inspection and Metallurgy*.** This RP provides guidance for the source inspector on welding fabrication inspection. Issues covered include: welding processes, procedures, welder qualifications, metallurgical affects from welding, inspection techniques, welding terminology and symbols, how to review a welding procedure, and a guide to common filler metals. The source inspector should be thoroughly familiar with the contents of Sections 3 to 10 of this RP.
- **API RP 578, *Material Verification Program for New and Existing Alloy Piping Systems*.** The purpose of this RP is to provide guidelines for a material and quality system to verify that the nominal composition of piping alloy components is consistent with the material specifications. The primary topics covered include: material verification test methods, evaluation of PMI test results, marking and record keeping. The source inspector should be thoroughly familiar with the contents of this RP except for the sections that focus on material verification for existing systems that are already in operation in a plant.
- **API Std 598, *Valve Inspection and Testing*.** This standard covers the inspection, examination, and pressure test medium and requirements for various kinds of valves utilized in the energy

industry. The various kinds of tests and examinations specified in this standard include: shell test, backseat test, low-pressure closure test, high-pressure closure test and visual examination of castings. The SI should look to the appropriate purchasing document and spec sheets for the required characteristics of each valve, such as type, size, materials, rating, trim, etc. The SI should be thoroughly familiar with the contents of API Std 598 whenever specified in contractual agreements. API Std 598 is mostly applied to standard metallic valves (butterfly, gate, globe, ball, etc.) used in ASME B31.1 or B31.3 applications.

8.2.5.3 ASME Codes and Standards

There are a wide variety of ASME Codes and Standards that may be included in the contractual agreements to specify equipment fabrication methods and control the quality of products for the energy industry. A few of those that the SI should be familiar with and apply when specified are shown in the following subsections; but this list is not all inclusive. Occasionally there may be other sections of the ASME *BPVC* that will be specified on different projects in which the SI will be involved.

- **ASME *BPVC* Section II—*Materials*.** This section of the *BPVC* is divided into four parts covering materials for the construction of piping and pressure vessels.
 - **Part A—*Ferrous Material Specifications*.** This part contains the individual specifications for ferrous materials that are allowed in the construction of pressure vessels and piping designed to the ASME *BPVC*. Part A covers all forms of ferrous material products like wrought, castings, forgings, plates, piping valves, bolting, etc. The issues addressed by each ferrous material specification vary based on the characteristics of the material and final use for which it is intended. Some examples of issues covered include: ordering information, heat treatment, chemical composition, mechanical properties, tests and examinations, dimensions and tolerances and the steel making practice. The source inspector should be familiar with the contents of whichever materials are specified in the contractual agreements. The only three specifications covered in ASME *BPVC* Section II, Part A that the SI need to be familiar with for purposes of the examination are:
 - SA-20, *General Requirements for Steel Plates*
 - SA-370, *Test Methods and Definitions of Mechanical Testing Steel Products*
 - SA-6, *Thickness Tolerances for Steel Plate*
 - **Part B—*Nonferrous Material Specifications*.** This part contains the individual specifications for nonferrous materials that are allowed in the construction of pressure vessels and piping designed to the ASME *BPVC*. Part B covers all forms of nonferrous material products like wrought, castings, forgings, plates, piping valves, bolting, etc. allowed for in the construction of ASME *BPVC* equipment. The types of nonferrous material alloys included in Part B are: aluminum, copper, nickel, titanium, and zirconium. The issues addressed by each nonferrous material specification vary based on the characteristics of the material and final use for which it is intended. Some examples of issues covered include: ordering information, heat treatment, chemical composition, mechanical properties, tests and examinations, dimensions and tolerances and the steel making practice. The source inspector should be familiar with the contents of whichever materials are specified in the contractual agreements. However there will be no specific questions on the core examination out of Part B, but the SI should be familiar with what the standard covers.

- **Part C—Specifications for Welding Rods, Electrodes and Filler Metals.** Part C covers material specifications for the manufacture, acceptability, chemical composition, mechanical usability, surfacing, testing, operating characteristics and intended uses of welding rods, electrodes and filler materials. The material specifications are designated by SFA numbers derived from AWS specifications. The source inspector would typically reference these specifications for whichever welding materials are specified in the contractual agreements to ensure that the right materials are being used in fabrication. However there will be no specific questions on the core examination out of Part C, but the SI should be familiar with what the standard covers.
- **Part D—Materials Properties.** Part D provides tables for design stress values, tensile strength, yield strength, and other important chemical and physical properties for all the material specifications contained in Parts A and B. This section is primarily intended for designers of ASME *BPVC* equipment. As such, there will be no specific questions on the core examinations out of Part D, but the SI should be familiar with what the standard covers.
- **ASME *BPVC* Section V—Nondestructive Examination.** This section of the *BPVC* contains requirements and methods for NDE techniques that are specified by other sections of the ASME *BPVC* and/or contractual agreements. Most of the common methods of NDE are covered in Section V including RT, UT, MT, PT, VT, and LT. Appendix A of Section V presents a listing of common imperfections and damage mechanisms and the NDE methods that are generally capable of detecting them. Section V also provides guidance on methods of evaluating NDE results. The source inspector should be thoroughly familiar with the contents of Section V for whichever NDE method is specified in contractual agreements and/or ITP. For the purposes of SI examination, some of the content covered in ASME *BPVC* Section V that applicants should focus on include:
 - All definitions in Subsection A, Article 1, Appendix 1 and Subsection B, Article 30, SE-1316
 - Article 1 on General Requirements for NDE
 - Article 4 on Ultrasonic Examination Methods of Welds
 - Article 6 on Liquid Penetrant Examination
 - Article 7 on Magnetic Particle Examination
 - Article 9 on Visual Examination
 - Article 10 on Leak Testing
 - Article 23, Section 797 on UT Thickness Testing
- **ASME *BPVC* Section VIII, Division 1—Rules for the Construction of Pressure Vessels.** Division 1 contains the requirements, specific prohibitions and non-mandatory guidance for standard design unfired pressure vessel materials, design, fabrication, examination, inspection, testing, certification and pressure relief requirements. Division 1 is divided into three subsections with mandatory and non-mandatory appendices. The source inspector should be thoroughly familiar with the contents of Division 1 with regard to the fabrication, examination, inspection and testing that is specified in contractual agreements and/or ITP. Some of the content covered in ASME *BPVC* Section VIII, Division 1 that the SI should be familiar with include:
 - Subsection A covers the general requirements applicable to all pressure vessels.
 - Subsection B covers specific methods of fabrication of pressure vessels e.g. welding

- Subsection C covers the various classes of materials used in the fabrication of pressure vessels e.g. steels, alloys, cladding, lining, low temperature materials, etc.

For the purposes of SI examination the applicants should focus their attention on the following sections:

- All definitions in Appendix 3
 - Materials, UG 4 to 15
 - Fabrication, UG 75 to 85
 - Inspection and Testing, UG 90 to 103
 - Marking and Reports, UG 115 to 120
 - Welding General, UW 1 to 3
 - Welding Materials, UW 5
 - Fabrication, UW 26 to 42
 - Inspection and Tests, UW 46 to 54
 - Marking and Reporting, UW 60
 - Postweld Heat Treatment, UCS 56
 - Radiographic Examination, UCS 57
- **ASME BPVC Section VIII, Division 2—Rules for the Construction of Pressure Vessels—Alternative Rules.** Division 2 also contains the requirements, specific prohibitions, and non-mandatory guidance for advance designed unfired pressure vessel materials, design, fabrication, examination, inspection, testing, certification and pressure relief. Division 2 is divided into nine parts, each with mandatory and non-mandatory annexes. The source inspector need not be thoroughly familiar with the contents of Division 2 for the core examination, but the SI should be familiar with what the standard covers.
 - **ASME BPVC Section IX—Qualification Standard for Welding and Brazing Procedures, Welders, Brazers, and Welding and Brazing Operators.** Section IX of the ASME BPVC Part QW covers the qualifications of welders, welding operators and the procedures that will be employed during fabrication. The primary subjects covered include: welding general requirements, welding procedure specifications and qualification, and welder performance qualification. Section IX does not cover acceptance criteria for production welds. Section IX also covers fabrication by brazing (Part QB), so the SI inspector should be aware of that section, but will not need to be familiar with it until and unless assigned to a project that specifies brazed construction. The source inspector should be thoroughly familiar with the contents of Section IX Part QW with regard to the WPS, PQR and WPQ that are specified in contractual agreements and/or ITP. For the purposes of SI examination the applicants need to focus their attention on the following sections of ASME BPVC Section IX :
 - Welding General Requirements QW 100 to 190
 - Welding Procedure Qualifications QW 200 to 290
 - Welding Performance Qualifications QW 300 to 380
 - Welding Data QW 400 to 490
 - Standard Welding Procedure Specifications QW 500 to 540

- **ASME B31.3—Process Piping.** B31.3 covers the requirements for the fabrication of process piping associated with pressure vessels typically used in the petrochemical industry. It covers design, materials, fabrication, welding, erection, testing, inspection and examination of process piping including flanges, fittings, gaskets, bolting, valves, PRV's. The source inspector should be familiar with the contents of B31.3 with regard to examination, inspection and testing procedures that are specified in contractual agreements and/or ITP. For the purposes of SI examination some of the content covered in ASME B31.3 that the applicants should be familiar with includes:
 - Chapter I, Scope and Definitions
 - Chapter III, Materials
 - Chapter IV, Standards for Piping Components
 - Chapter V, Fabrication, Assembly and Erection
 - Chapter VI, Inspection, Examination and Testing
- **ASME B16.5—Pipe Flanges and Flanged Fittings.** B16.5 covers the requirements for materials, dimensions, tolerances, marking, testing of flanges and flanged fittings, as well as flange bolting and gaskets. B16.5 covers flange class designations for 150, 300, 400, 600, 900, 1500 and 2500 systems for sizes from NPS ½ to NPS 24 made from cast or forged materials. These pressure classes have differing pressure and temperature ratings for different materials of construction. B16.5 also covers blind flanges and reducing flanges. The source inspector would use this standard to verify that flanges and flanged fittings specified in the contractual document have been correctly supplied. For the purposes of the SI examination the applicants should be familiar with the following sections of ASME B16.5:
 - Chapters 1 to 8, narrative information and associated tables referenced therein

8.2.5.4 ASNT Standards

- **ASNT SNT-TC-1A.** This recommended practice establishes a general framework for a qualification and certification program for NDE technicians. In addition the standard provides recommended educational requirements and training requirements for different test methods. The SI should be thoroughly familiar with this standard, including the duties and responsibilities for each of the 3 levels of NDE qualified technician.

8.2.5.5 AWS Standards and References

- **The Welding Inspection Handbook.** This Handbook provides information to assist welding inspectors and supervisors in the technology and application of visual and nondestructive examination associated with welding. The SI should be thoroughly familiar with the contents of this handbook.
- **AWS D1.1 Structural Welding Code.** This code covers the welding requirements for any type of welded structure made from the commonly used carbon and low-alloy constructional steels. The SI inspector should be familiar with the following sections:
 - Scope and Application
 - Requirements for the Welding Inspector
 - Welding Inspection Operations

- Inspection Safety Considerations
- Preheating and Postweld Heat Treating
- Weld and Weld Related Discontinuities
- Destructive Testing of Welds
- NDE Methods
- Qualification of NDE Personnel

8.2.5.6 SSPC Standards

- **SSPC-PA 2 Coating Applications Standard No. 2, Procedure for Determining Conformance to Dry Coating Thickness Requirements.** This standard describes a procedure for determining conformance to a specified dry film thickness (DFT) range on metal substrates using NDE thickness gauges. The SI inspector should be familiar with Sections 1 to 8 of this standard.
- **SSPC Surface Preparation Guide.** This guideline briefly describes the scope of the 7 different SSPC and NACE Surface Preparation Standards with application to source inspection. The source inspector should be familiar with the scope of the 7 standards listed below that are included in this guide, but need not be familiar with the details in the specific standards for examination purposes.
 - SSPC-SP1—*Solvent Cleaning*
 - SSPC-SP3—*Power Tool Cleaning*
 - SSPC-SP5 or NACE 1—*White Metal Blast Cleaning*
 - SSPC-SP6 or NACE 3—*Commercial Blast Cleaning*
 - SSPC-SP7 or NACE 4—*Brush-Off Blast Cleaning*
 - SSPC-SP10 or NACE 2—*Near-White Blast Cleaning*
 - SSPC-SP11—*Power Tool Cleaning to Bare Metal*

8.2.6 Welding Procedures and Qualifications

For fixed and mechanical equipment and materials, welding procedure qualifications are the responsibility of the S/V while it is the responsibility of the source inspector that they be verified as the ones approved by engineering. Prior to performing welding inspection, the SI should confirm that the version of the WPS in hand has been reviewed and approved by the responsible person e.g. engineer/WPS/PQR SME. The *AWS Welding Inspection Handbook*, ASME BPVC Section IX, AWS D1.1 and API RP 577 are the appropriate references for knowledge and understanding of WPS/PQR's.

8.2.7 NDE Procedures

Development of NDE procedures are the responsibility of the S/V while it is the responsibility of the source inspector that they be verified as the ones approved for use. Prior to witnessing NDE, the SI should confirm that the version of the NDE procedure in hand has been reviewed and approved by the responsible person e.g. engineer/NDE SME. The *AWS Welding Inspection Handbook*, ASME BPVC Section V, AWS D1.1 and ASNT SNT-TC-1A are the appropriate references for knowledge and understanding of NDE procedures and required training and certification of NDE technicians.

8.2.8 Project Schedules

While the responsibility of establishing and monitoring the delivery is not generally in the purview of the SI and the responsibility of meeting the schedule remains with the S/V, the SI may be requested to report on fabrication status or slippage of milestone progress. The SI should notify the inspection coordinator if he/she believes that product quality may be compromised by schedule pressures.

8.3 Performing the Source Inspection

8.3.1 Individuals assigned to perform the source inspection activity must follow the ITP as specified by the purchaser. Visual inspection, welding inspection, dimensional inspections, observing NDE, and all other examinations and tests must be performed in accordance with the source ITP, project specification and applicable code and standards and meet the applicable acceptance criteria. See Section 9 for Examination Methods, Tools and Equipment.

8.3.2 One important step in the source inspection work process is to verify evidence that the S/V personnel conducting the fabrication and quality control steps during fabrication are properly trained, qualified and certified, as specified in the ITP or other contractual documents. This may include verification of such credentials as: S/V quality personnel qualifications per the specified standards, checking welder log books, and NDE technician certifications per the specified standards, such as ASNT SNT TC-1A, EPRI, or API Industry Qualified Examiners.

8.3.3 During the course of M&F, the S/V may propose work process changes that could impact cost, schedule and/or quality. In such cases, the source inspector should request that the S/V propose such changes in writing for review by the purchaser and/or owner-user of the equipment.

8.4 Source Inspection Work Process Scheduled Planning Events

8.4.1 General

Typical source inspection scheduled work process events include the following.

8.4.2 Pre-purchase Meeting (Prior to Contract Placement)

The source inspector may or may not participate in a pre-purchase meeting. The purpose of such a meeting is to cover some specific design, fabrication, and/or QA/QC requirements expected of the S/V to make sure that their bid does not inadvertently overlook them and result in unanticipated surprises during fabrication and source inspection activities.

8.4.3 Pre-inspection Meeting (Prior to Start of Fabrication)

The source inspector assigned to the S/V facility should participate in the pre-inspection meeting. The purpose of this meeting is to ensure that everyone at the S/V who will be involved in manufacturing, fabrication and monitoring the quality of the equipment fully understands specific requirements and details of the job, especially those requirements that may be non-routine or different relative to normal S/V quality surveillance. Advance preparation by the source inspector is important for the pre-inspection meeting to ensure the meeting covers all necessary issues requirements as specified in the contractual agreements and source inspector's company policy/practices. Those requirements may include review of:

- PO and contractual agreements

- Engineering, technical and material requirements and status
- Fabrication schedules
- Critical path and long-lead equipment/materials
- Quality requirements e.g. ITP, NCR, inspection frequency, etc.
- Sub-suppliers and their quality requirements
- Special requirements e.g. performance or functional testing requirements
- Painting, preservation and tagging
- Communication requirements e.g. inspection point notification, report distribution, proposed changes, hold points, schedule impacts, etc.
- Shipping and release plan
- Final documentation requirements
- Recording and reporting any observations, exceptions or deviations

These source inspection work process events may also be observed or handled by others besides the source inspector including: project engineering, client representatives or third party inspection agency.

8.5 Report Writing

8.5.1 A key deliverable of source inspection is the progressive inspection reports detailing the documents reviewed, inspection activity performed, observed and/or witnessed during the source inspection visits. The report is normally on a standard format, and follows a consistent approach to reporting as specified by the purchaser.

8.5.2 The source inspector should reference the following minimum information in each report:

- Date of visit
- Appropriate contract number and key information
- Purpose of visit
- Action items or areas of concerns
- Results of inspection/surveillance
- Reference drawings/data used (including drawing numbers) to perform inspection/surveillance
- Revisions of referenced drawings/data
- Reference to the applicable requirement in the ITP
- Identification of nonconforming or deviating items/issues

8.5.3 Photographs are common place in inspection reports as they assist in the description of the inspection results. The SI should request permission from the S/V prior to taking any photographs. Care should be exercised to ensure that an appropriate number of photos are attached as too many can be detrimental to report issuance due to file size. Photos should be dated and labeled with description of

area of interest or product tag reference so that they can be easily understood by those reading the SI reports.

8.5.4 Reports should be submitted to the inspection coordinator for review of content and technical clarity before they are distributed to the purchaser unless otherwise instructed.

8.6 Nonconformance/Deviations

8.6.1 When deviations to the contractual agreement or its referenced specifications, drawings, codes or standards are identified, the source inspector should identify them as nonconformances. The source inspector should notify the inspection coordinator as soon as practical once a nonconformance has been identified.

8.6.2 Nonconformance reports should reference the following minimum information:

- Date of inspection
- Contract number and information
- Description of nonconforming item and issue
- Photo of discrepancy if possible
- specification, drawings, codes or standards involved
- Impact on the product
- S/V recommended disposition of the nonconformance

8.6.3 The source inspector should issue the nonconformance report to the inspection coordinator for review and distribution unless instructed otherwise.

8.6.4 In general, deviations from specifications must be approved by the responsible engineer/technical personnel.

8.6.5 Acceptable disposition of a nonconformance (as approved by the responsible engineer/SME) may include:

- Use as is
- Rework/repair per original contractual documents or approved repair procedure
- Scrap the equipment/component involved and start over

8.6.6 Once the disposition of the nonconformance has been agreed by all appropriate parties and implemented, the source inspector is normally responsible for determining if the nonconforming item currently conforms to the original or revised requirements based on the agreed disposition. It is SI responsibility to verify that NCR disposition has been properly implemented.

8.7 Source Inspection Project Continuous Improvement

At the completion of the source inspection activities at an S/V, the source inspector, inspection coordinator, and all others involved in the “planning and doing” processes should review the entire planning and doing part of the “Plan–Do–Check–Adjust” continuous improvement (CI) cycle to determine which activities went well and where improvements/adjustments could/should be made. Determinations

should be made if improvements are possible and necessary in the source inspection management systems; the source inspection project planning process: the creation and implementation of the ITP; and the implementation of the source inspection work process events. Any such improvements should be documented and made available to source inspection managers and coordinators to implement the improvements. This should include an evaluation of the performance of the S/V.

8.8 Source Inspector Continuous Improvement

The source inspector can/should also learn from the continuous improvement cycle how he/she can improve their performance on the job by answering such questions as:

- Are there some industry codes and standards that I should be more familiar with?
- Are there any safety and/or personal conduct improvements I can make?
- Can I improve the way I write the various SI reports?
- Do I need to improve my review of project documents before showing up at the S/V site?
- Can I improve the way I conducted the pre-fabrication meeting?
- Can I improve the timeliness of closing out my part of the source inspection project?

9 Examination Methods, Tools and Equipment

9.1 General

This section describes the typical examination methods, tools and equipment with which source inspectors should be familiar during the course of their surveillance at an S/V. Requirements for examinations from the purchaser or references in the contract agreement that may be more stringent than industry codes/standards or the S/V normal procedures should be included in the ITP.

9.2 Review and Confirmation of Materials of Construction

9.2.1 Ensuring that the S/V is using the correct material during the fabrication or manufacturing of the equipment is a critical element of quality surveillance. Typical reviews should consist of the following:

- Material Test Reports (MTRs)—The information necessary for the source inspector to know and understand about MTRs is covered in API RP 577, Section 10.8 and ASME *BPVC* Section II, SA-370.
- Any reports e.g. MTR's that have been modified, corrected, or altered should be cause for immediate rejection as these could indicate the potential for the material or component being counterfeit material. All MTR's must be legible.
- Confirming that the construction materials proposed are the actual materials used during construction is a typical source inspection activity. The source inspector should:
 - Confirm the correct material type and grade.
 - Confirm the origin of the material.
 - Check material size and/or thickness.
 - Verify traceability of the material to a certifying document.

- Verify that the material complies with specific chemical and/or mechanical properties as specified in the contractual documents.
- Check for evidence of specified heat treatment.
- This is typically done by verifying that material grade, type and serial number match the material certifying document. Some S/V's quality programs as well as purchasers' have various methods for ensuring that the correct material is used in manufacturing with the use of positive material identification (PMI). The source inspector should be familiar with those methods and ensure compliance. API RP 578 is a good reference document for material verification and positive material identification.

9.2.2 The SI should be aware of the potential for counterfeit materials/documents slipping into the supply chain. Key issues to watch for include, but are not limited to:

- Generic documentation which is not product specific
- Material or equipment containing minimal or no documentation
- Markings or logos that are questionable or obliterated
- Items that have inconsistent appearance
- Documents that have been altered
- Items that lack material traceability or product certification
- ASME or ASTM stampings that may have been counterfeited

9.3 Dimensional Inspections

9.3.1 The SI should be proficient in understanding and performing dimensional inspections. Equipment such as tape measures, dial indicators, calipers, protractors, levels are all typical tools that are used for dimensional inspection. See the Welding Inspection Handbook and API RP 577 for further information on SI tools of the trade.

9.3.2 When performing dimensional inspections, the source inspector should be familiar with the dimensional requirements and the allowable tolerances. Actual dimensions should be recorded in the inspection reference drawing. Dimensions which exceed the tolerances should be reported as a nonconformance or deviation.

9.4 Visual Inspections

9.4.1 Adequate lighting is essential when performing visual inspection. The SI must be familiar with the minimum lighting requirements defined by the applicable code, standard or specification. If there is inadequate lighting available during the visual inspection which is not uncommon in some shops, the source inspector must address these concerns with the S/V and inspection coordinator to resolve. Portable lighting such as pen lights, high power flashlights, etc. are common tools that the source inspector may need with him/her in order to perform adequate visual inspection.

9.4.2 Source Inspectors who are performing visual inspections of welding, coatings, etc. should be appropriately trained, qualified and/or certified as required to perform those activities in accordance with the applicable codes or standards including the visual acuity requirements.

9.5 Nondestructive Examination (NDE) Techniques

9.5.1 General

9.5.1.1 The primary source for the specific NDE techniques to be applied during M&F by the S/V is included in the applicable project specifications. Those documents should reference other appropriate codes/standards for NDE methods such as ASME *BPVC* Section V and NDE technician qualifications such as ASNT SNT TC-1A. The source inspector should be familiar with the NDE qualification/certification processes described in ASNT SNT TC-1A, especially what NDE duties/responsibilities can be carried out by Levels I, II, and III NDE technicians.

9.5.1.2 The source inspector should be familiar with NDE terminology contained in ASME *BPVC* Section V, Subsection A, Article 1, Mandatory Appendix 1 and Subsection B, Article 30, SE-1316.

9.5.2 Penetrant Testing (PT)

API RP 577, Section 9.6 and ASME *BPVC* Section V, Article 6, T-620 cover most of what the source inspector needs to know about PT. Discontinuities revealed during PT are normally recorded on an NDE report.

9.5.3 Magnetic Testing (MT)

API RP 577, Section 9.4 and ASME *BPVC* Section V, Article 7, T-750 cover most of what the source inspector needs to know about MT. Discontinuities revealed during MT are normally recorded on an NDE report.

9.5.4 Radiographic Testing (RT)

API RP 577, Section 9.8 and ASME *BPVC* Section V, Article 2, T-220 and SE-797 cover most of what the source inspector needs to know about RT. Discontinuities revealed during RT are normally recorded on an NDE report.

9.5.5 Ultrasonic Testing (UT)

API RP 577, Section 9.9 and ASME *BPVC* Section V, Article 4, and SE 797 and Article 5, T-530 cover most of what the source inspector needs to know about UT. Discontinuities revealed during UT are normally recorded on an NDE report.

9.5.6 Hardness Testing (HT)

API RP 577, Sections 9.10 and 10.4.3 and in Table 11 cover most of what the source inspector needs to know about hardness testing.

9.5.7 Positive Material Identification (PMI)

API RP 578 covers most of what the source inspector needs to know about material verification and PMI.

9.6 Destructive Testing

9.6.1 Destructive testing is defined as those tests that are performed on metals for the purposes of determining mechanical properties and which involve testing of sample coupons. Examples of such tests include tensile testing, bend testing and Charpy impact testing.

9.6.2 Tensile testing is performed to determine yield strength (point at which elastic deformation becomes plastic/permanent deformation) and ultimate tensile strength (fracture point) of an item.

9.6.3 Bend testing is commonly performed on weld coupons to check the ductility and integrity of welds.

9.6.4 Charpy impact testing is performed to determine toughness of metals and welds. It may be specified for a variety of reasons at a variety of different temperatures to show that the vessel or piping system has the ability to deform plastically before failing i.e. avoid catastrophic brittle fracture. For many construction codes, impact testing often becomes a requirement below temperatures of -20°F , but the engineering specifications may require impact testing at other temperatures as well.

9.6.5 Most of the information necessary for the source inspector to know and understand about destructive testing of metals is covered in API RP 577, Section 10.4.

9.7 Pressure/Leak Testing

9.7.1 General

Pressure/leak testing is normally specified by the applicable codes/standards and contractual agreements.

9.7.2 Pressure Testing

9.7.2.1 Pressure testing is normally specified to check for leaks or determine whether or not there may be gross errors in design or fabrication that could cause the component to fail (fracture, crack or deform) under pressure. Pressure tests in shops are usually conducted with water (hydrotesting) or with air (pneumatic testing) or a combination of both (hydro-pneumatic testing). As the name indicates, pressure testing involves testing with elevated pressures, often above that at which the component will normally operate, so safety is of utmost importance when witnessing a pressure test. Pressure tests must be conducted in accordance with the construction code or standard to which the item was built e.g. ASME *BPVC* Section VIII for vessels or ASME B31.3 for process piping. These codes generally indicate how to witness such a test safely after the pressure has equalized and stabilized. Whether testing by hydrotest, hydro-pneumatic or pneumatic, the pressure testing equipment should have the means to prevent overpressuring the equipment under test. The SI should check that.

9.7.2.2 Hydrotesting is the most common method of pressure testing and involves the application of pressure using water. It's very important that high point vents be opened during filling and before the application of pressure to ensure that there is no air left in the system. Water is considered non-compressible while air is very compressible. The compression of air left in equipment during hydrotesting can lead to catastrophic brittle fracture and severe injury if the tested commodity were to fail during the test.

9.7.2.3 Pneumatic Testing is generally conducted with air though sometimes it's conducted with a combination of air and water. There are significantly greater risks involved in higher pressure pneumatic testing, so it should never be conducted without the full knowledge and consent of the responsible engineer who has been satisfied that the potential for brittle fracture during test is negligible. The danger lies in pieces of the equipment that fails under pneumatic pressure being propelled with great force for long distances and thereby doing a lot of damage and/or inflicting severe injury.

9.7.2.4 Leak Testing is generally the term used to describe low pressure testing with air or gas just to see if the joints in a piece of equipment e.g. flanges and threaded connections are leak tight after assembly. Leak tests are usually done at low pressures which are substantially below equipment design pressures to minimize risk of injury. Specialized leak tests with helium or other gases have to be specified by contractual documents which will detail the leak test procedure and generally reference an industry standard that must be followed.

9.8 Performance/Functional Testing

Performance and functional testing is generally not applicable to fixed equipment like vessels and piping and is more related to machinery, instruments, analyzers, and control systems to determine that the equipment will perform as specified in service. In situations where the SI is involved in performance/functional testing, a specific procedure with acceptance criteria will be involved and often an engineer or other SME will also witness the test. Unless otherwise specified in the contractual documents, the performance testing of vessels and piping is generally limited to assuring that they are leak free.

9.9 Surface Preparation/Coatings Inspections

9.9.1 Performance of coating systems typically depends on the how well the substrate or surface is prepared for coating applications. Typically on fixed equipment, visual inspection of surface preparation is recommended or required. Inspections typically consist of:

- Surface profile measurement
- Visual surface comparison
- Verification of blasting medium

9.9.2 Coating systems are usually specified in the contractual and engineering documents and likely will involve single or multi coating applications. The method of inspection of these coating systems is by the use of a dry film thickness gauge (DFT) per SSPC-PA 2, which the SI should be familiar with.

9.9.3 The SI should also be aware of specific coating requirements such as stripe coating of welds, edges, corners, etc. which are performed to insure coating performance on rough or uneven surfaces.

9.9.4 In addition to purchase order requirements and company standards, coating manufacturer's recommendations will provide the details for correct coatings application to be followed.

9.9.5 Prior to releasing the fixed equipment for shipment, the source inspector should inspect the coated or lined surfaces for the following items: raised areas, pinholes, soft spots, disbondment, delaminations, blisters, holidays, bubbling, fisheyes, runs and sags, uniformity, mechanical damage, orange peel, adhesion, mud flat cracking and proper color or shade.

9.9.6 Any areas found in need of coating repairs should be properly identified and documented (NCR) by the source inspector as well as any testing and re-inspection performed after repairs have been made.

10 Final Acceptance

10.1 Prior to final acceptance of fixed equipment, the source inspector should determine the following:

- All work specified in the contractual agreements is completed by the S/V
- All NCRs have been closed out and resolved by the S/V QC representative and owner's QA representative
- All punch list items have been completed
- All Inspection related activities have been completed and documented
- All S/V work has been deemed acceptable by the owner's QA representative in accordance with the requirements of codes, standards and project specifications.

10.2 Shipping Preparations may also be specified in the contractual and engineering documents. It is important that the SI confirm that all bracing, strapping, mounting, covering, packaging, marking, and protection from the weather, etc. is effectively completed before the equipment is released for shipment.

10.3 Reviewing Final S/V Data. It is typical for the SI to perform a final review of the contractually required S/V data upon the completion of the manufacturing/fabrication and prior to shipment of the materials or equipment. This review is to determine that all documents are complete, with the as built item with all supporting documents as identified in the contractual agreement. Such documentation may include but is not limited to:

- Final fabrication drawings
- MTR's
- Pressure test documentation
- NDE results
- Product specific QC checks
- NCR close outs
- Certification documents
- Code compliance documentation

11 Manufacturing and Fabrication (M&F) Processes

11.1 General

11.1.1 The manufacturer/fabricator is responsible for the quality of all their M&F products, which includes not only good workmanship, but also compliance with all codes, standards and specifications contained in the contractual agreements. The source inspector is responsible as defined in the inspection and test plan (ITP) for performing the source quality surveillance activities at the S/V facilities in accordance with the applicable ITP.

11.1.2 Specific M&F processes that are commonly used include welding, heat treatment, casting, forming, forging, machining, assembly, etc. The source inspector needs to be familiar with those M&F processes to confirm compliance with codes, standards and project document requirements. For all M&F processes including rework and repair, the following information should be consistent and confirmed:

- M&F process has a documented method describing how to perform the work
- Individuals required to perform the M&F process have proof of training and qualifications

- Individuals performing the work have immediate access to the relevant M&F procedures
- There is acceptance criteria documented to determine if the M&F processes results are acceptable
- The results of the M&F processes are documented

11.1.3 Rework and repair—should be approved by the purchaser and verified by the SI.

11.2 Welding Processes and Welding Defects

Typical welding processes used in M&F of equipment are described in API RP 577, Section 5, and the variety of potential welding defects are covered in API RP 577, Section 4.5. The SI should be familiar with these sections. Different welding processes are susceptible to different types of welding defects. Hence it's important for the SI to know which welding processes will be applied to the equipment during M&F and to be familiar with the typical defects for each welding process that can occur.

11.3 Casting

11.3.1 The casting process is used to create simple or complex shapes from any material that can be melted. This process consists of melting the material and heating it to a specified temperature, pouring the molten material into a mold or cavity of the desired shape, and solidification of the material to form the finished shape. An advantage of the casting process is that a single step process can be used to produce components that are characterized by one or more of the following attributes:

- Complex shapes e.g. fittings, flanges, valve bodies
- Hollow sections or internal cavities
- Irregular curved surfaces
- Very large sizes
- Materials that are difficult to machine

11.3.2 A disadvantage of castings for pressure components is that mechanical properties such as toughness may not be adequate. Typical defects associated with the casting process that the SI should be aware of include:

- Shrinkage voids
- Gas porosity
- Trapped inclusions

11.3.3 Castings are susceptible to the creation of voids during the casting process which could result in through wall leaks during service. ASTM grades of casting used in the petrochemical industry typically for pump casings and valve bodies are referenced in ASTM A703, *Standard Specification for Steel Castings, General Requirements for Pressure Containing Parts*. This standard prohibits peening, plugging and impregnating defects in castings to stop leaks, as opposed to making more permanent welding repairs. The SI should make sure that any casting repairs needed are brought to his/her attention so that adequate repair procedures can be prepared, approved by the purchaser and implemented. ASTM 703 also provides casting grade symbols that identify the type of material in the casting.

11.3.4 Grade symbols are required on valve castings (e.g. WCB, WC9, CF8M, and so forth) in order to indicate the type of casting material. The SI should verify that the casting grade symbol on products e.g. valve bodies matches the specified grade in the contractual documents.

11.3.5 MSS-SP-55, Quality Standard for Steel Castings for Valves, Flanges and Fittings and Other Piping Components—Visual Method for Evaluation of Surface Irregularities is the standard that is generally used to perform visual evaluation of surface irregularities that may have occurred during the casting process. The source inspector accepting cast products should be familiar with this standard.

11.4 Forging

11.4.1 Forging is the oldest known metal working process. It consists of a number of processes that are characterized by the use of localized compressive forces that are applied via hammers, presses, dies, or other forging equipment to induce plastic/permanent deformation. While forging may be performed in all temperature ranges, most forging is done above the recrystallization temperature of metal. During the forging process the grain flow follows the general shape of the component and results in improved strength and toughness characteristics. Advantages of this change include:

- Increased wear resistance without increased hardness/loss of ductility
- Stronger/tougher than an equivalent cast or machined component
- Less expensive alloys can be used to produce high strength components
- Components are not susceptible to common casting defects

11.4.2 ASTM A788, *Standard Specification for Steel Forgings, General Requirements* covers a group of common requirements that may be applied to steel forgings for general use. Key elements of ASTM A788 include the following:

- The purchaser may specify additional requirements
- Tension and hardness tests must be conducted to evaluate mechanical properties
- Repair welding is not allowed unless permitted by the product specification
- Supplementary general requirements may be performed by agreement between the supplier and the purchaser; these requirements are designated by an S followed by a number (e.g. S5)

11.5 Machining

11.5.1 Machining is any of several metal working processes in which a piece of raw material is cut into a desired final shape and size by a controlled material-removal process. Typical fixed equipment components that require machining include: flanges, valve components, and heat exchanger tube sheets. The three principal machining processes are turning, drilling and milling. Other machining operations include shaping, planing, boring, broaching and sawing.

11.5.1.1 Turning operations are operations that rotate the workpiece as the primary method of moving metal against the cutting tool. Lathes are the principal machine tool used in turning.

11.5.1.2 Milling operations are operations in which the cutting tool rotates to bring cutting edges to bear against the workpiece. Milling machines are the principal machine tool used in milling.

11.5.1.3 Drilling operations are operations in which holes are produced or refined by bringing a rotating cutter with cutting edges at the lower extremity into contact with the workpiece. Drilling operations are done primarily in drill presses but sometimes on lathes or mills.

11.5.2 Machining requires attention to many details for a workpiece to meet the specifications set out in the engineering drawings or blueprints. Besides the obvious problems related to correct dimensions, there is the problem of achieving the correct finish or surface smoothness on the workpiece such as a flange finish. Typically there is no in-process inspection by the SI for the machining operation; however, the SI may be required to check dimensional aspects and tolerances of machined components.

11.6 Assembly

Assembly generally has more to do with machinery, instrumentation, control systems, and electrical gear looking for fit/form/function. However, for mechanical equipment such as skid units and other equipment that is to be assembled e.g. flanges or other connections, the SI should be looking for tight fit up of all connectors. This can be accomplished with torque wrenches or “pinging” bolts with a small hammer (like a slag or ball peen hammer). The SI should check to make sure that bolted flanges and screwed fittings are leak free when witnessing hydrotests.

11.7 Metallurgy Issues Associated with Manufacturing and Fabrication Processes

11.7.1 The Structure and Metals

Metallurgy is a complex science in which many schools have four degreed programs, but a general understanding of the major principles is important to the source inspector, due to the wide variety of metals and alloys that may be used in manufacturing and fabrication processes including welding. Most of the information necessary for the source inspector to know and understand about metallurgical issues is covered in API RP 577, Section 10, with which the SI should be familiar.

11.7.2 Physical Properties of Metals

The physical properties of a metal or alloy are those, which are relatively insensitive to structure and can be measured without the application of force. Examples of physical properties of a metal are the melting temperature, the thermal conductivity, electrical conductivity, the coefficient of thermal expansion, and density. Most of the information necessary for the source inspector to know and understand about the physical properties of metals is covered in API RP 577, Section 10.3.

11.7.3 Mechanical Properties of Metals

Engineers select materials of construction that provide adequate strength and toughness at operating temperatures and pressures. For the inspector, verification that mechanical properties meet the design requirements is essential. Inspectors should understand the underlying principles of mechanical properties and the nature of tests conducted to verify the value of those properties. Most of the information necessary for the source inspector to know and understand about the mechanical properties of metals is covered in API RP 577, Section 10.4.

11.7.4 Hardness and Hardenability of Metals

Hardenability is defined as that property of a ferrous alloy that determines the depth and distribution of hardness induced by quenching. It is important to note that there is not a close relationship between

hardenability and hardness, which is the resistance to indentation. Hardness depends primarily on the carbon content of the material, whereas hardenability is strongly affected by the presence of alloying elements, such as chromium, molybdenum and vanadium, and to a lesser extent by carbon content and alloying elements such as nickel, copper and silicon. Most of the information necessary for the source inspector to know and understand about the hardness and hardenability of metals is covered in API RP 577, Section 10.7.

11.7.5 Weldability of Metals

The American Welding Society defines weldability as “the capacity of a metal to be welded under the fabrication conditions imposed, into a specific, suitably designed structure, and to perform satisfactorily in the intended service.” Most of the information necessary for the source inspector to know and understand about the weldability of metals is covered in API RP 577, Sections 10.9 and 10.10.

11.7.6 Preheating and Postweld Heat Treatment

11.7.6.1 Preheating

Preheating is defined as heating of the weld and surrounding base metal to a predetermined temperature prior to the start of welding. The primary purpose for preheating carbon and low-alloy steels is to reduce the tendency for hydrogen induced delayed cracking. It does this by slowing the cooling rate, which helps prevent the formation of martensite (a more crack prone microstructure) in the weld and base metal HAZ. According to B31.3, the pre-heat zone for welding of new process piping should extend at least one inch beyond the edge of the weld for piping. Most of the information necessary for the source inspector to know and understand about preheating is covered in API RP 577, Section 10.5.

11.7.6.2 Postweld Heat Treatment (PWHT)

Postweld heat treatment (PWHT) produces both mechanical and metallurgical effects in carbon and low-alloy steels that will vary widely depending on the composition of the steel, its past thermal history, the temperature and duration of the PWHT and heating and cooling rates employed during the PWHT. The need for PWHT is dependent on many factors including; chemistry of the metal, thickness of the parts being joined, joint design, welding processes and service or process conditions. The temperature of PWHT is selected by considering the changes being sought in the equipment or structure. PWHT is the most common form of fabrication heat treatment applied to fixed equipment. When PWHT is required by code, typical normal holding temperatures for carbon and some alloy steels is 1100°F for one hour per inch of thickness with 15 minute minimum. When PWHT is required for equipment due to in-service process considerations, those requirements will most likely be found in company standards and specified in the project documents. Normally the appropriate PWHT for welded equipment and piping is specified in the welding procedure specification (WPS). Heating and cooling rates for PWHT may be specified in the construction code or project documents. Typically heating rates for pressure equipment and piping above 800°F must be controlled to no more than 400°F per hour with no variation permitted of more than 250°F in any 15 foot segment of the equipment. Thermocouples must be located in order to verify even distribution of temperature on components and to ensure that no component is over or under-heated during PWHT. Most of the information necessary for the source inspector to know and understand about PWHT is covered in API RP 577, Section 10.6; ASME *BPVC* Section VIII, Division 1, UCS-56; and B31.3, 331.

11.7.6.3 Other Heat Treatments

Other heat treatments for vessels and piping include annealing, normalizing, solution annealing, and tempering. See Section 3 for definitions of those heat treatments.

12 Pressure Vessels

12.1 General

A pressure vessel is a container designed to withstand internal or external pressure. The pressure vessels are typically constructed in accordance with ASME *BPVC* Section VIII or other recognized international pressure vessel codes, or as approved by the jurisdiction. These codes typically limit design basis to an external or internal operating pressure no less than 15 psig (103 kPa). However, vessels can also operate at lower pressures. External pressure on a vessel can be caused by an internal vacuum or by fluid pressure between an outer jacket and the vessel wall. Columns, towers, drums, reactors, heat exchangers, condensers, air coolers, bullets, spheres, and accumulators are common types of industry pressure vessels.

Pressure vessels are designed in various shapes. They may be cylindrical (with flat, conical, toriconical, semispherical, semi-ellipsoidal, or hemispherical heads), spherical, or boxed (with flat rectangular or square plate heads, such as those used for the headers of air-cooled exchangers), or lobed. They may be of modular construction. Cylindrical vessels, including exchangers and condensers, may be either vertical or horizontal and may be supported by steel columns, cylindrical plate skirts, or plate lugs attached to the shell. Spherical vessels are usually supported by steel columns attached to the shell or by skirts. Spheroidal vessels are partially or completely supported by resting on the ground. Jacketed vessels are those built with a casing of outer shell that forms a space between itself and the main shell. The primary difference between a tank and a vessel is that tanks generally operate at lower pressures, often at or just above atmospheric pressures.

12.2 Vessel Methods of Construction

Several different methods are used to construct pressure vessels. Most pressure vessels are constructed with welded joints. Shell rings are usually made by rolling plate at either elevated or ambient temperature. The cylinder is formed by welding the ends of the rolled plate together. This yields a cylinder with a longitudinal weld. Hot forging is another method of making cylindrical vessels. Some vessel manufacturers hot forge cylindrical shell rings for high pressure, heavy wall vessels such as those used for hydrotreater or hydro cracker reactors. This method does not produce a longitudinal seam in the cylinder.

12.3 Vessel Materials of Construction

12.3.1 Carbon steel is the most common material used to construct pressure vessels. For special purposes, a suitable austenitic or ferritic alloy, Alloy 400, nickel, titanium, high-nickel alloys or aluminum may be used. Copper and copper alloys (except Alloy 400) are seldom used in refinery vessels but are common with heat exchanger tubes and may be found in petrochemical plant vessels.

Materials used to construct the various parts of heat exchangers are selected to safely handle the service and the heat load required. Materials that will most economically resist the type of corrosion expected are selected.

Exchanger shells are usually made of carbon steel but may be made of a corrosion-resistant alloy or clad with a corrosion-resistant material. Exchanger channels and baffles are made of carbon steel or a suitable corrosion-resistant alloy material, usually similar to the material of the tubes.

12.3.2 Tubes for exchanger bundles may be a variety of materials. Where water is used as a cooling or condensing medium, they are generally made of copper based alloys or steel. In water applications where copper alloys or steels will not provide sufficient corrosion protection, higher alloy materials may be used such as duplex stainless steel, or the tube ID may be coated (baked epoxy or similar). Titanium may be used in seawater applications. Where the exchange is between two different hydrocarbons, the tubes may be made of steel or a suitable corrosion-resistant alloy. Tubes, consisting of an inner layer of one material and an outer layer of a different material (bimetallic), may in some cases be required to resist two different corrosive mediums.

12.3.3 Tube sheets for exchanger bundles are made of a variety of materials. Where water is the cooling or condensing medium, they are usually made of admiralty brass or steel, but may also be constructed of high-alloy steels (clad or solid). Titanium may be used in seawater applications. Where the exchange of heat is between two hydrocarbons, the tube sheets may be composed of steel or a suitable corrosion-resistant alloy. In some cases it may be necessary to face one side of the tube sheet with a material different from that facing the other to resist two different corrosive mediums.

If carbon steel would not resist the corrosion or erosion expected or would cause contamination of the product, vessels may be lined with other metals or nonmetals. A lined vessel is usually more economical than one built of a solid corrosion-resistant material. However, when the pressure vessel will operate at a high temperature, a high pressure, or both, solid alloy steels may be both necessary and economical.

Internal metallic layers are installed in various ways usually to provide more corrosion resistance than would be provided by the carbon steel base layer. Those layers may be an integral part of the plate material (cladding) rolled or explosion bonded before fabrication of the vessel. They may instead be separate sheets of metal fastened to the vessel by welding. Corrosion-resistant metal can also be applied to the vessel surfaces by various weld overlay processes. Metallic liners may be made of a ferritic alloy, austenitic alloy e.g. 300 series stainless steels, Alloy 400, nickel, or any other metal resistant to the corrosive agent.

12.3.4 Austenitic stainless steels (type 300 series) come in a variety of Cr/Mo/Ni/Fe contents. The most widely used are the 18Cr/8Ni series known as 18/8 stainless steels, like type 304, 347, and 321 grades. Type 321 and 347 are stabilized grades that will avoid sensitization of the HAZ during welding and therefore retain most of their corrosion resistance during fabrication. Type 321 is stabilized with small amounts of Ti; while type 347 is stabilized with small amounts of Nb.

Some type 300 stainless steels also come in “L” grades like 304L, 316L, and 317L. The “L” stands for low carbon. These low carbon grades are also more resistant to sensitization of the HAZ during welding.

Some type 300 stainless steels also come in “H” grades like 304H, 316H, and 317H. The “H” stands for high carbon. These high carbon grades are stronger at high temperatures than the lower carbon grades.

12.3.5 All materials used for the construction of pressure vessels should have traceability. For example, acceptable methods of traceability for plates used in the fabrication of vessels include:

- Plate number

- Lot number
- Heat number

12.3.6 Nonmetallic liners may be used to resist corrosion and erosion, reduce fouling potential (i.e. exchanger tubes), or to insulate and reduce the temperature on the walls of a pressure vessel. The most common nonmetallic lining materials are reinforced concrete, acid brick, refractory material, insulating material, carbon brick or block, rubber, phenolic/ epoxy coatings, glass, and plastic.

12.3.7 Pressure vessels constructed out of nonmetallic materials are usually made from fiber reinforced plastic (FRP) and can be more resistant to some corrosive services. FRP can be made with different resins as the matrix material and typically use glass fiber as the reinforcement. Reinforced thermoset plastics are a type of FRP that is more rigid due to the use of a thermoset resin for the matrix rather than a thermoplastic. Both of these nonmetallic materials have varying strength due to the type of fiber used, fiber weave, and the lay-up of the fiber layers.

12.4 Vessel Internal Components

Many pressure vessels have no internals. Others have internals such as baffles, distribution piping, trays, mesh- or strip-type packing grids, catalyst bed supports, cyclones, pipe coils, spray nozzles, demister pads, and quench lines. Large spheroids may have internal bracing and ties and most vacuum vessels have either external or internal stiffening rings. Some pressure vessels have heat exchangers or reboilers located in the lower shell area.

12.5 Vessel Design and Construction Standards

In the U.S. and many other countries, pressure vessels are typically constructed in accordance with ASME *BPVC* Section VIII which is divided into three parts, Division 1, Division 2, and Division 3. Section VIII, Division 1 provides requirements applicable to the design, fabrication, inspection, testing, and certification of pressure vessels operating at either internal or external pressures exceeding 15 psig. Section VIII, Division 2 provides alternative and more stringent rules for the design, fabrication, and inspection of vessels than those found in Division 1. Most pressure vessels for U.S. refineries are now built to conform to the latest edition of Section VIII, Division 1. Some high-pressure vessels are designed and built in accordance with the specifications of Division 2. Section VIII, Division 3 provides alternative rules for construction of high-pressure vessels with design pressure generally above 10 ksi (70 MPa).

The ASME *BPVC* requires that welding procedures and welders who construct pressure vessels be compliant with Section IX of the ASME *BPVC*. The SI is responsible for ensuring that procedures and welders are so qualified.

In Annex A, the most common types of ASME Code Symbol Stamps are shown. These stamps are applied to vessel nameplates by ASME certified shops upon completion of the vessel or PSV to show compliance with a particular section of the ASME *BPVC*. The SI should be familiar with these code stamps.

Both Divisions 1 and 2 of Section VIII of the ASME *BPVC* require the manufacturer of a vessel to have a quality assurance system. Before the manufacturer can obtain a certificate of authorization from ASME, a written quality manual must be provided and approved, and the system must be implemented. The quality assurance system requires detailed documentation of examinations, testing, and design data regarding

the vessel and provides a history of the construction of the vessel. This documentation is necessary when evaluating vessels after being placed in service.

The ASME *BPVC* lists materials that may be used for construction, provides formulas for calculating thickness, provides rules on methods of manufacture, and specifies the procedures for testing completed vessels. Inspection is required during construction and testing of vessels. The code also prescribes the qualifications of the persons who perform the construction inspections i.e. code authorized inspectors (AI).

After an authorized construction inspector of the jurisdiction (AI) certifies that a vessel has been built and tested as required by the ASME *BPVC*, the manufacturer is empowered to stamp the vessel with the appropriate symbol of the ASME *BPVC*. The SI should be aware that the AI is only interested that the vessel is built to the specified construction code e.g. ASME *BPVC*. Additional requirements which may be specified in the contractual documents (and often are included), but potentially more stringent than the construction code requirements will not be addressed by the AI; so the SI will need to more diligent when reviewing those requirements not contained in the code of construction.

The symbol stamped on a pressure vessel is an assurance by the manufacturer that the vessel has been designed, constructed, tested, and inspected as required by the ASME *BPVC*.

Some states and cities and many countries have laws and regulations beyond that of the ASME *BPVC* (and other codes) that govern the design, construction, testing, installation, inspection, and repair of pressure vessels used in their localities. These laws may supersede the ASME *BPVC*'s (and other code's) minimum requirements.

Construction codes are periodically revised as the designs of pressure vessels improve and as new and improved construction materials become available. However, it's vital that the SI make sure that the vessels are constructed in accordance with the editions of the codes specified in the contractual agreements, which may not be the same as the current editions of codes and standards.

12.6 Dimensional Check of Pressure Vessels

The SI should conduct dimensional checks of pressure vessels to ensure they are within the required tolerances of the specification. At a minimum these checks consist of the following:

- Mill under-tolerance of plates and pipes
- Tolerances for formed heads
- Out-of-roundness of shell
- Nozzles and attachments orientation
- Nozzles and attachments projection
- Nozzles and attachments elevation
- Nozzles and attachments levelness
- Weld mismatch
- Weld reinforcement

12.7 Heat Exchangers

12.7.1 Exchangers are used to reduce the temperature of one fluid by transferring heat to another fluid without mixing the fluids. Exchangers are called condensers when the temperature of a vapor is reduced to the point where some or all of the vapor becomes liquid by the transfer of heat to another fluid, often water. When a hot fluid is cooled to a lower desired temperature by the transfer of heat to another fluid, the exchanger is usually referred to as a cooler. When air is used to reduce the temperature of a hot liquid to a lower desired temperature, the exchanger is referred to as an air cooler (or fin-fan).

12.7.2 There are several types of shell and tube-bundle exchangers. Usually, the tubes are attached to the tube sheet by expansion (rolling). The tubes may be rolled and welded or attached by packing glands. A description of some of the types of exchangers commonly used follow.

12.7.3 Exchangers are equipped with baffles or support plates, the type and design of which vary with the service and heat load the exchanger is meant to handle. Pass partitions are usually installed in the channels and sometimes in the floating tube-sheet covers to provide multiple flows through the tubes. The flow through the shell may be single pass, or longitudinal baffles may be installed to provide multiple passes. The baffling used in the shell will determine the location and number of shell nozzles required. Frequently, an impingement baffle plate or rod baffle is located below the shell inlet nozzle to prevent impingement of the incoming fluid on the adjacent tubes.

12.7.4 The tubes may be arranged in the tube sheet on either a square or a triangular pitch. When the fluid circulating around the outside of the tubes may coke or form other dirty deposits on the tubes, the square pitch is generally used. The square pitch arrangement permits better access for cleaning between the tubes.

12.7.5 An air-cooled unit (sometimes referred to as a fin-fan) is similar to an exposed tube bundle unit; however, air is used as the cooling medium. A bank of tubes is located in a steel framework through which air is circulated by a fan placed either above or below the tube bank (a fan above the tube bank is usually referred to as an induced draft air cooler and a fan below the tube bank is usually referred to as a forced draft air cooler). These coolers may be used for the condensing or cooling of vapors and liquids and are installed where water is scarce or for other reasons. API 661 covers the minimum requirements for design, materials, fabrication, inspection, testing, and preparation for delivery of air coolers.

12.7.6 In the U.S., heat exchangers and condensers are designed and built in accordance with ASME *BPVC*, TEMA Standards, API 660—*Shell-and-Tube Heat Exchangers*, and API 661—*Air-Cooled Heat Exchangers for General Refinery Services*. (Other countries may have equipment design requirements other than ASME, TEMA, and API.) As with all fixed equipment items, the M/F is responsible for ensuring that the fabricated heat exchanger complies with the TEMA Standard when it is specified in the contractual documents. Sections 2 and 3 of the TEMA Mechanical Standard for shell and tube exchangers are pertinent to the SI, as they cover:

- Fabrication tolerances
- Shop inspection
- Nameplates
- Code data reports
- Preparation for shipment

13 Piping

13.1 General

For piping designed and fabricated to ASME B31.3, the SI is responsible to verify that all required examinations and testing have been completed and to inspect the piping to the extent necessary to be satisfied that it conforms to all applicable specification and examination requirements for ASME B31.3 and the engineering design. Process piping in the oil, gas and chemical industry is designed and fabricated to B31.3, while power piping (associated with boilers) is designed and fabricated to B31.1.

13.2 Valves

13.2.1 There are various methods for manufacturing valves. The purchase order documents should be checked to determine what methods apply. The valve bodies and bonnets are typically made of cast or forged material. The body and bonnet are then machined as required by the valve specification. The seat may be integral with the body or a seat ring would be welded or threaded into place. The seat or seat ring would normally be hard surfaced. The valve disc (closure mechanism) would be machined from bar or plate and may also be hard surfaced before machining. The valve is then assembled, stem packing added (where required) and then tested, typically to API Std 598.

13.2.2 When performing source inspection for valves, the SI should review the purchase order for required valve characteristics (i.e. size, material, rating, trim, etc.) and verify that the valves meet the specification.

13.2.3 Valve pressure testing is normally required for the shell, seat leakage, back seat and packing. Hydrostatic testing is normally applied per API Std 598; however pneumatic testing is normally applied for seat leakage testing. The test medium, pressures and holding times should be in accordance with the contractual documents and/or API Std 598.

13.2.4 API Std 598 does not apply to every valve that is manufactured. API Std 598 is mostly applied to standard metallic valves (butterfly, gate, globe, ball, etc.) used in ASME B31.1 or B31.3 applications. Other specialty valves (such as relief valves, control valves), may have to be tested in accordance with other standards as specified in the purchase order documents. It is the responsibility of the SI to confirm the requirements in the purchase order documents.

13.2.5 NDE requirements for valves (body, bonnets, welding, weld preps) are not found in API Std 598. NDE requirements for valves will be governed by the applicable piping code (ASME B31.3 or B31.1), and/or the purchase order documents.

13.2.6 Marking on valves at a minimum shall comply with the requirements of MSS-SP-25, *Standard Marking System for Valves, Fittings, Flanges and Unions* unless otherwise specified in the purchase order documents. Markings shall be applied to the body of a valve or an identification plate.

13.2.7 Markings indicating conformance with a recognized document/standards (such as ASME, ANSI, AWWA, API, UL/FM, etc.), may be applied only by authorized, licensed or approved manufactures. Such markings shall be applied only to the products that fully comply and may be shown on the body or an attached plate at the option of the manufacturer.

13.2.8 Flow directional indication shall be marked on unidirectional valves. Commonly used markings include arrows, or the words "inlet" or "outlet" marked on the appropriate end.

13.2.9 Other product markings which can be cast, forged or engraved on the body, or put on a permanently attached tag include:

- Manufacturer's name, trademark or symbol unless the size or shape does not permit.
- The rating designation, which is one of the required markings. The rating can be in the form of recognized national standard pressure class (i.e. 150#, 300#, etc.). If the valve does not conform to a recognized national standard, the rating may be shown by numbers and letters representing the pressure rating at maximum/minimum temperatures.
- ASTM/ASME material identification (not required for some copper/brass materials and gray/ductile iron).
- Melt identification (heat number).
- Valve trim identification (stem-disc-seat).
- Size designation, usually this will be the nominal pipe size. In some instances where the closure size is smaller than the inlet/outlet size, the size will be shown as (nominal pipe size) x (closure pipe size). For example if the inlet/outlet pipe size is 6" and the closure pipe size is 4" then the size of the valve will be shown as 6X4.
- Special Identification (such as UL/FM, B16.34, NACE, etc.).
- When the shape or size does not permit inclusion of all the required markings, some markings may be omitted starting with the least important information such as size.
- Required markings, if shown on the body, need not be duplicated on the identification plate.

13.3 Flanges

13.3.1 A flange is a method of connecting piping segments as well as piping to valves, pumps and vessels. Flanges are usually welded or screwed into such systems and then joined with bolts. The SI should be familiar with the different types used on the equipment in the contractual documents. Proper controls must be exercised in the application of flanges in order to attain a joint that has leak tightness. Special techniques, such as controlled bolt tightening (torquing/tensioning) are described in ASME PCC-1, *Guidelines for Pressure Boundary Bolted Flange Joint Assembly*.

13.3.2 Pipe flanges that are made to standards such as ASME B16.5 (see 8.2.5.3) or ASME B16.47 are typically made from forged materials and have machined surfaces for gaskets.

13.3.3 ASME B16.5 covers NPS's from ½" to 24" and ASME B16.47 covers NPS's from 26" to 60". Each specification further delineates flanges into pressure classes: 150, 300, 400, 600, 900, 1500 and 2500 psi for ASME B16.5; ASME B16.47 delineates its flanges into pressure classes 75, 150, 300, 400, 600, 900.

13.3.4 ASME B16.48 covers piping line blanks (blinds).

13.3.5 The gasket type and bolt type are generally specified by ASME *BPVC* Section VIII, Division 1, Appendix 2.

13.3.6 Flanges are recognized by ASME Pipe Codes such as ASME B31.1, *Power Piping* and ASME B31.3, *Process Piping*. Materials for flanges are usually covered in ASME designation: SA-105 (*Specification for Carbon Steel Forgings for Piping Applications*), SA-266 (*Specification for Carbon Steel*

Forgings for Pressure Vessel Components), or SA-182 (*Specification for Forged or Rolled Alloy-Steel Pipe Flanges, Forged Fittings, and Valves and Parts for High-Temperature Service*).

13.3.7 Typical types of flanges include:

- **Weld Neck Flange:** This flange is circumferentially welded into the system at its neck which means that the integrity of the butt welded area can be easily examined by radiography. The bores of both pipe and flange match, which reduces turbulence and erosion inside the pipeline. The weld neck is therefore favored in critical applications
- **Slip-on Flange:** This flange is slipped over the pipe and then fillet welded to the pipe, both on the ID and OD.
- **Blind Flange:** This flange is used to blank off pipelines, valves and pumps; it can also be used as an inspection cover. It is sometimes referred to as a blanking flange.
- **Socket Welded Flange:** This flange is counter bored to accept the pipe before being fillet welded.
- **Threaded Flange:** This flange is referred to as either threaded or screwed. It is used to connect other threaded components in low pressure, non-critical applications. The advantage of threaded flanges is that no welding is required.
- **Lap Joint Flange:** These flanges are used with a stub end which is butt welded to the pipe with the flange loose behind it. This means the stub end creates the sealing face for the flange gasket. The lap joint is favored in low pressure applications because it is easily assembled and aligned.
- **Ring Type Joint (RTJ) Flange:** This is a flanging method of providing leak proof flange connections in high pressure service. A metal ring is compressed into a hexagonal groove on the face of the flange to make the seal. This jointing method can be employed on Weld Neck, Slip-on and Blind Flanges.
- Other types of specialized or proprietary connectors may be specified on certain equipment. The SI should become familiar with these types of connectors if they are specified in the contractual documents.

13.3.8 Flanges have different types of faces i.e. sealing surfaces for different services, such as raised-face, flat face, ring joint and lap joint. Raised-face is the most common type.

13.3.9 There are many various types of flange gaskets used for proper bolted flange joints including spiral wound, compressed asbestos, graphite, ring joint, corrugated metal, double-jacketed, rubber, Teflon, etc. Flange gaskets allow mated flanges to be sealed under the proper bolt load.

13.3.10 Spiral wound gaskets are becoming increasingly common in the hydrocarbon production and process industries. They comprise a mix of metallic rings and filler material with inner and/or outer rings. Generally, the spiral wound gasket has a metal alloy wound outwards in a circular spiral with a filler material (typically a flexible graphite or PTFE) wound in the same manner but starting from the opposing side. This results in alternating layers of filler and metal. The filler material in these gaskets acts as the sealing element, with the metal providing structural support. These gaskets have proven to be reliable in most applications, and allow lower clamping forces than solid gaskets. Once installed in a bolted flange assembly, the type and material of spiral wound gaskets can be identified by color coding on the outside edge. It is important for the SI to verify that a bolted flange assembly contains the specified gasket or premature gasket failure could occur resulting in a leak or blow out.

13.4 Fittings

13.4.1 There are several types of pipe fittings. Piping systems designed and fabricated to ASME B31.3 utilize forged, wrought and cast fittings. Fitting components commonly used include elbows, couplings, unions, reducers, o-lets, tees, crosses, caps, blanks (blinds) and plugs.

13.4.2 Manufacturing processes used to make fittings consist of forgings, bars, plates, seamless or fusion welded tubular products with filler metal added.

13.4.3 Construction materials of carbon steel and alloy steel must conform to the chemical requirements provided in the applicable industry standard specification.

13.4.4 The source inspector must be familiar with the specified information vital to the quality of manufactured fittings; heat treatment, chemical composition, mechanical properties e.g. tensile and impact test properties, dimensions, surface quality, inspection and testing, certification and product marking.

13.4.5 Manufacturing tolerances for widely used wrought fittings may be found in ASME B16.9 for butt welding fittings and ASME B16.11 for socket weld and threaded fittings.

14 Structural Components

14.1 The basic design code for fabrication and erection of structural steel is the American Institute of Steel Construction (AISC). The primary sections of the AISC generally used include (but are not limited to):

- AISC 303—*Code of Standard Practice for Steel Buildings and Bridges*
- AISC 325—*Steel Construction Manual*
- AISC 348—*Specification for Structural Joints Using ASTM A325 or A490 Bolts*
- AISC 360—*Specification for Structural Steel Buildings*

The applicability of the above referenced codes will be identified in the purchase order documentation. For purposes of the SI examination, the SI need not be familiar with the contents of these standards.

14.2 The welding of structural steel generally falls under the requirements of AWS D1.1; however, in some instances AISC does provide specific limitations or requirements that supersede the requirements of AWS D1.1.

14.3 When NDE is required, the process, extent and standards of acceptance will be defined in the purchase order documentation.

14.4 Dimensional tolerances are generally in accordance with AISC 303 unless specifically shown on the shop drawing.

14.5 ASTM A6 specification covers a group of common requirements for structural steel that, unless otherwise specified in the material specification, is applied to rolled structural steel bars, plates, shapes and sheet piling. The specification provides dimensions and permitted variations for structural shapes.

14.6 Materials used for structural steel must be new and meet the requirements of ASTM A6 unless otherwise noted in the purchase order documents. Material substitution (grade, sizes, shapes of equivalent strength) are not allowed without engineering approval.

14.7 ASTM A325, A325M, A490 and A490M are used for high strength structural bolts.

14.8 Marking: All structural steel must be clearly marked for field erection (member identification). All markings are to be placed on the steel in a legible fashion.

Structural member identification will generally be performed using one of the following methods:

- Stamped on the member
- Corrosion resistant tag wired to the member
- Corrosion resistant coating

In all cases, the member marking shall be clearly visible on the member after any galvanizing process.

If required by the purchase order documents, erection marks or member weight marking may also be required to aid in field erection.















14.9 Coating/galvanizing:

- Members and parts to be galvanized should be designed, detailed and fabricated to provide for flow and drainage of pickling fluids and zinc and to prevent pressure build up in enclosed parts
- Galvanizing should be in accordance with ASTM A123 or A153 unless otherwise specified in the purchase order documents
- Shop painting is not required unless specified by the purchase order documents
- Except for contact surfaces, surfaces inaccessible after shop assembly shall be cleaned and painted prior to assembly
- Machine-finish surfaces shall be protected against corrosion by rust inhibitive coating that can be removed prior to erection or which has characteristics that make removal prior to erection unnecessary

Annex A





Most Common Types of ASME and NB Code Symbol Stamps





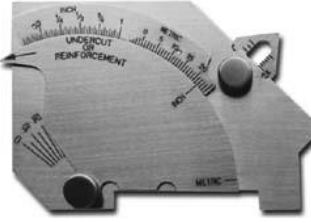

The symbol in the far left column was used prior to 2013. The ASME symbol with lower designator in the second column is the replacement code symbol stamp as of 2013.





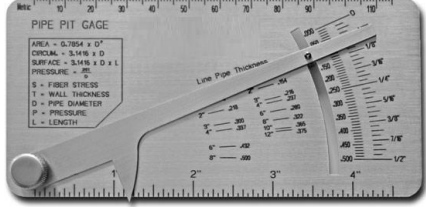

Pressure Vessels—Section VIII, Division 1		
		Pressure Vessels
		Pressure Vessels Safety Valves
Pressure Vessels—Section VIII, Division 2		
		Alternative Rules for Pressure Vessels
Pressure Vessels—Section VIII, Division 3		
		High Pressure Vessels
Power Boilers—Section I		
		Power Boilers
		Pressure Piping
		Power Boiler Safety Valves
National Board Inspection Code Symbol Stamps		
	R	Repair and Alteration
	VR	Repair of Safety Valves





Annex B





Photos of various types of tools for use by the Source Inspector



Equipment	Picture	
Flash Lights		Supplemental light source for visual inspection.
Tape Measures 5'		Dimensional inspection
Bridge Cam Gages		Multi-purpose welding inspection gage that can be used to verify angles of welded preparation, excess weld cap size, undercut depth, fillet throat size and surface misalignment.
Hi LO Gages		Measures internal alignment for components to be welded.
Radiograph Viewer 4" x 17"		Light source for reviewing radiographic film
Radiograph Film Densitometer		Tool designed to measure the degree of darkness or density of radiographic film.

<p>Digital Calliper</p>		<p>Instrument used to measure distance between opposite sides of an object. Typically used for close tolerance dimensions on machined parts.</p>
<p>OD Micrometer</p>		<p>Instrument used to measure outside diameters/dimensions. Typically used for close tolerance dimensions on machined parts.</p>
<p>Pit gage</p>		<p>Measures the depth of weld undercut or other surface discontinuities.</p>
<p>Inspection Mirrors</p>		<p>Tool designed to support visual inspection in limited and/or obscured areas.</p>
<p>Temperature Indicator</p>		<p>Used for reading temperatures by changing from solid to liquid at a specific temperature.</p>
<p>Laser Thermal Gun</p>		<p>Tool for measuring surface temperature.</p>
<p>Clamp on Amp Meter</p>		<p>Tool designed to measure electric current in amperage and voltage. May be used for checking welding machine settings.</p>

<p>Digital Surface Profile Gage</p>		<p>Tool designed to measure the surface roughness for material that is about to be coated.</p>
<p>Surface Profile Replica Tape</p>		<p>Tool designed to replicate surface profile and measure surface roughness.</p>
<p>Wet Gauge</p>		<p>Tool for measuring un-cured thickness of coating.</p>
<p>Camera</p>		<p>Tool for photographic record keeping.</p>
<p>Magnifying Glass</p>		<p>Tool for enhanced visual inspection.</p>
<p>Positive Material Identification Tool</p>		<p>Tool designed to verify or measure chemical content.</p>
<p>Ferrite Meter</p>		<p>Tool to measure the ferrite (iron phase) content in stainless steels.</p>

<p>Portable Brinell Tester</p>		<p>Tool for measuring surface hardness.</p>
<p>Vibration Meter</p>		<p>Tool designed to measure mechanical oscillations.</p>
<p>Borescope</p>		<p>Designed for remote visual inspection.</p>
<p>Liquid Penetrant Kit</p>		<p>NDE technique for finding discontinuities open to the surface.</p>
<p>Ultrasonic Thickness Meter</p>		<p>Tool commonly used for measuring metal thickness.</p>

<p>Vacuum Box</p>		<p>Tool for measuring leakage in welded components</p>
<p>Ultrasonic Flaw Detection</p>		<p>Volumetric NDE method for finding weld flaws.</p>
<p>Inside Micrometer Set</p>		<p>Used for measuring inside diameters.</p>
<p>Depth Micrometer</p>		<p>Used for measuring depth.</p>
<p>Precision Gage Blocks</p>		<p>Used for calibration of precision measurement equipment.</p>

<p>Bore Gage</p>		<p>Measures inside diameter of components.</p>
<p>Magnetic Particle Testing</p>		<p>Tool designed to detect surface and near surface discontinuities in ferrous materials.</p>
<p>Level</p>		<p>Device used to determine horizontally level and/or vertically plumb</p>

Images used with the permission of Krypton, Olympus (<http://www.olympus-ims.com/en/>), Starrett (<http://www.starrett.com>), Silverwing (<http://www.silverwingndt.com/>), Thermo Scientific (<http://www.niton.com/en/>) and Tempil (<http://www.tempil.com/>).

Annex C

Different Types of Bolted Flange Connections

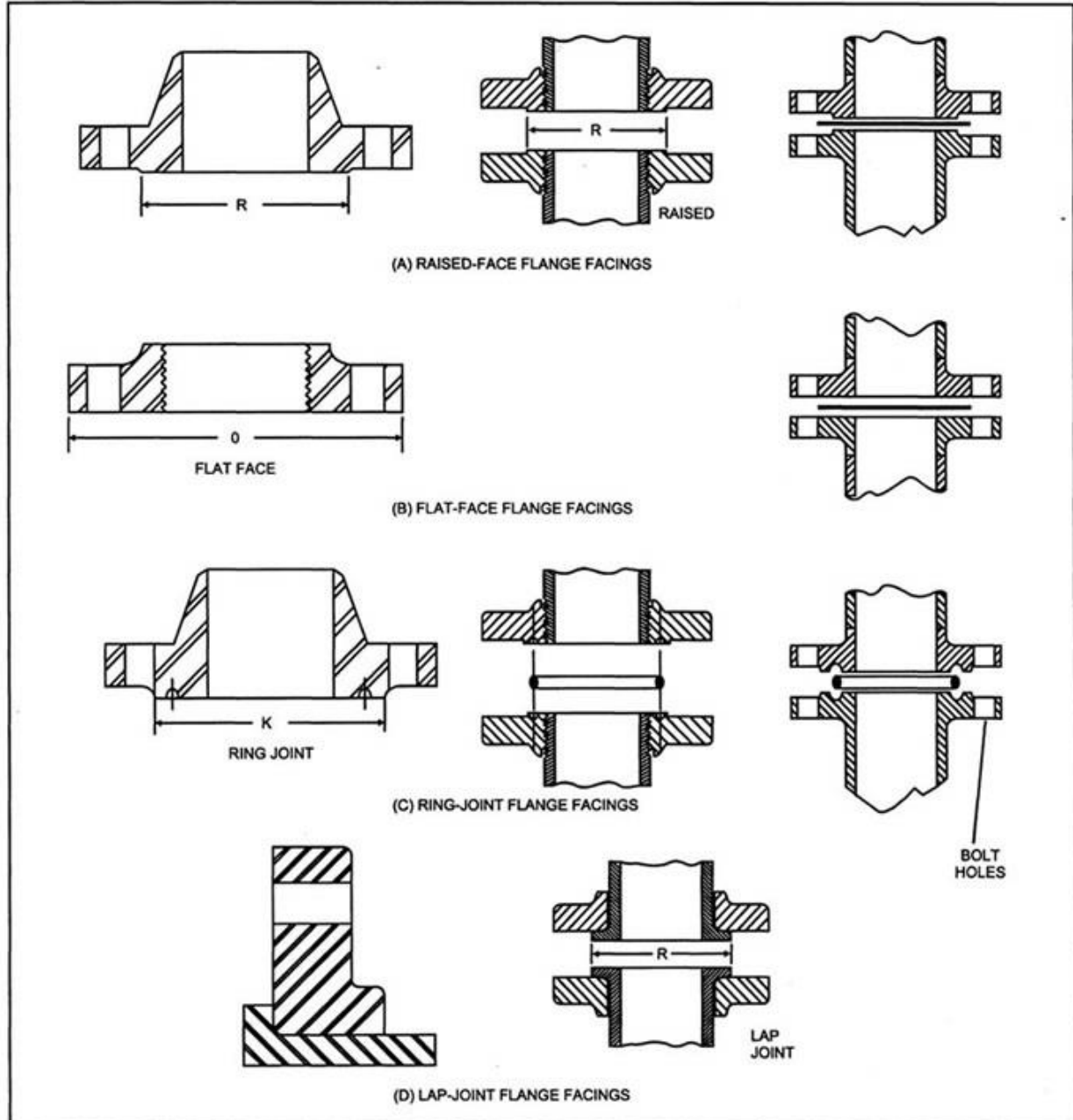

Image Courtesy of EPRI: *Guidelines for the Selection and Application of Power Plant Control Valves*

Different Types of Flange Faces (Sealing Surfaces)